

SGX 2000 USERS MANUAL TABLE OF CONTENTS

INTRODUCTION.....	1
GETTING STARTED.....	2
INSTALLATION.....	3
CONNECTIONS.....	3
Power.....	3
Inputs.....	3
Outputs.....	3
1/4" Outputs.....	3
XLR Outputs.....	4
Headphone Outputs.....	4
Effect Loop Send and Return.....	4
Effect Loop 1.....	4
Effect Loop 2.....	4
MIDI Out.....	4
MIDI In.....	4
MIDI Thru.....	5
PWR Out.....	5
CONTROLS AND OPERATION.....	5
Input Level Indicators.....	5
Digital Processor Input Level Control.....	5
Mains/XLR Output Level Control.....	5
Seven Segment Display.....	6
Liquid Crystal Display.....	6
LED Effect Indicator Array.....	6
Rotary Controls.....	7
Encoder.....	7
Drive.....	7
Second Stage Equalization.....	7
Thrust.....	7
Growl.....	7
Warmth.....	7
Crunch.....	7
Edge.....	7
Tube Drive Contour.....	7
Left/Right Balance.....	7
Stereo Master Output.....	7
Push Switches.....	8
Master Override:	
EFX Loop 1.....	8
EFX Loop 2.....	8
CONTROL BUTTONS.....	8
FUNCTION BUTTONS.....	8
Preset.....	8
Mix.....	9
Param.....	9
Value.....	10
Bypass.....	10
Edit Mode.....	11
EDIT MODE CONTROL BUTTONS.....	11
Enter.....	11
Recall.....	11
Add Effect.....	11
Delete Effect.....	12
Store.....	13

Rec/Arm.....	13
Trigger.....	13
Title Edit.....	14
Utility.....	14
Bypass Level.....	15
Remote Switch 1 & 2.....	15
Auto PM Display.....	16
LCD View Angle.....	16
Software Version Level.....	16
Preset Memory Allocation.....	16
Recall Factory Preset.....	16
Preset 1-110 Locked/Unlocked.....	17
MIDI.....	17
MIDI Enable.....	17
MIDI Channel.....	17
OMNI Mode.....	17
MIDI Program Table.....	18
FX On/Off Enable (Using X-15).....	18
MIDI Event data Monitoring Mode.....	18
PRESS ENTER TO:.....	19
SEND A PRESET (19); SEND ENTIRE MIDI PROGRAM TABLE	
(19); SEND ALL PRESETS (19)	
PERFORMANCE MIDI.....	19
DESCRIPTION OF ALGORITHMS.....	20
ANALOG EFFECT ALGORITHMS.....	21
Compressor.....	21
Expander.....	21
Distortion.....	22
Harmonic Exciter.....	22
Envelope Filter.....	23
Noise Gate.....	23
SIGNAL FREQUENCY SHAPING ALGORITHMS.....	23
Equalizer.....	23
Acoustic Environment Simulator.....	24
Low Pass Filter.....	25
Pitch Transposer.....	25
SWEPT OR MODULATED EFFECT ALGORITHMS.....	26
Flanger.....	26
Chorus.....	26
Panner.....	27
MIDI-Pan.....	27
Tremolo.....	27
NATURAL REVERBERATION ALGORITHMS.....	27
Reverb-1.....	28
Reverb-2.....	28
Reverb-3.....	29
GATED REVERBERATION ALGORITHMS.....	29
Gate-Verb-1.....	29
Gate-Verb-2.....	30
Gate-Verb-3.....	30
DELAY ALGORITHMS.....	30
Tapped DDL-S.....	30
Tapped DDL-L.....	30
Regen DDL-S.....	31
Regen DDL-L.....	31
Stereo DDL-S.....	31
Stereo DDL-L.....	32

Sampler-S.....	32
Sampler-L.....	32
Sampler+Ptr.....	33
SYSTEM CONTROL/LEVEL ALGORITHMS.....	34
Patch Bay.....	34
Digital Contour.....	34
Programmable Level.....	35
Tuner	35
How to use the Tuner.....	36
MIDI DATA MONITOR.....	37
PERFORMANCE MIDI Data Monitor.....	37
MIDI EVENT MONITOR.....	37
MISCELLANEOUS INFORMATION.....	40
About the Presets.....	40
Battery Backup.....	40
Low Battery Indicator.....	40
Software Revision Level.....	40
User Registration Card.....	40
Factory Reset.....	40
Other Means of Bypassing the SGX 2000.....	40
X-15	41
Customer Service.....	41
ART SGX 2000 SPECIFICATION.....	41
APPENDIX A.....	43
Building Your Own Presets.....	43
Level Programming Hints When Building Your Own Presets.....	43
Using Your Head (Amplifier).....	44
Guitar/SGX 2000/Amp.....	44
Guitar/Amp/SGX 2000 in Amp Effects Loop.....	44
Miscellaneous Suggestions.....	45
APPENDIX B.....	46
EXAMPLES.....	46
Copying a Preset.....	46
Factory Reset.....	46
Editing the MPT from the SGX 2000 front panel controls.....	46
Editing the MPT with a keyboard or external controller.....	47
INCREMENT PROGRAM.....	47
Setting up a preset sequence including a bypass preset.....	48
Programming the REMOTE jack for Incrementing Programs.....	48
Adding Performance MIDI to an existing preset.....	49
APPENDIX C.....	50
SGX 2000 MIDI Messages.....	50
System Exclusive Messages.....	50
Detailed Description of Messages.....	51
APPENDIX D.....	52
MIDI Implementation Chart.....	52
APPENDIX E.....	54
MIDI Controllers & Numbers.....	54
Default MIDI Controller Numbers.....	54
APPENDIX F	55
Guitar Or Keyboard Into SGX 2000, Controlled by an X-15 ULTRAFOOT.....	55
APPENDIX G.....	56
Using the SGX 2000 With an X-15 ULTRAFOOT.....	56
WARRANTY	57
SGX 2000 PRESET LIST.....	58
How to Read the Preset Description.....	
Table of Effect Abbreviations.....	61

INTRODUCTION

Thank you and congratulations on your new ART purchase. The SGX 2000 combines the dazzling effects of ART's own digital VLSI technology with applied analog and tube technology. The result is an incredible preamp/analog/digital effects processor offering a level of processing resolution with the sound quality of multiple devices. This new technology boasts 24 bit architecture, classic tube circuitry, the latest in analog circuit technology, and an amazingly easy user interface.

FEATURES:

- * 20KHz bandwidth
- * New ASIC 24 bit digital integrated effects system
- * Tube and analog preamp circuitry
- * Premium selected 12AX7 tube
- * Over 70 effects to choose from
- * Built in guitar/bass tuner
- * Better than 90 dB signal to noise ratio
- * Multi-function rotary encoder
- * Over two octaves of pitch transposing
- * 200 memory locations
- * 115 factory presets
- * Pitch Transposer and Reverb combination
- * Sampling capabilities
- * Direct interface capability with the ART X-15 ULTRAFOOT
- * Full programmability of all parameters
- * Programmable mix and level
- * Stereo inputs and outputs
- * Two assignable remote jacks
- * Power supply contained in unit
- * 9 volt DC output jack
- * Full MIDI system exclusive codes
- * Random access keypad
- * MIDI data monitor
- * Programmable 7 band equalizer

The SGX 2000 has the capability of providing you a virtually endless number of sounds and effects. ART designed powerful processing and ease of use into the SGX 2000. We strongly suggest you read this manual while getting used to your new SGX-2000.

Record for your reference:

DATE OF PURCHASE _____

PURCHASED FROM _____

SERIAL NUMBER _____

SOFTWARE VERSION _____

500-5004-101

GETTING STARTED

We have included this section for those of you who can't wait to experience the power of your new SGX-2000. Follow the hookup directions for the setup you use and then start playing. After the initial thrill wears off (if that's possible!), and you want to get to know your SGX-2000 better, refer to the rest of this manual for details, hints, and examples. Till later.....

Additional information to get you started can be found in Appendix A.

A block diagram showing signal flow, inputs and outputs can be found on page 51.

A hookup diagram can be found on page 52.

For all hookup combinations:

- 1) With the exception of the Encoder, set all the knobs to the 12:00 position and center the slider controls. All presets were configured with the control knobs set at 12:00 and the sliders centered.
- 2) Select any preset with the Encoder and start playing.
- 3) Use the Stereo Master Output control to increase or decrease your output level. To adjust your input gain, use the Input Drive control. The Second Stage Equalizer controls on the front panel allow you to tweak the curve of each preset and acts much like the tone controls on a guitar amp.
- 4) For maximum distortion crunch, turn the Drive control towards maximum.
- 5) If you are in a preset using the Tube Distortion, adjust the characteristic sound of the tube with the Tube Contour control.
- 6) The presets of the SGX-2000 are grouped together for various sounds and applications. Locations 1 thru 21 are set up for instant use with a guitar, try presets 22 thru 30 with an X-15 ULTRAFOOT and guitar for foot control of the effects. Check out presets 31 thru 45 for delay effects such as chorus and flange. Presets 46 thru 49 have no digital effects, just raw tube and solid state power. The rest of the presets are a collection of killer and clean sounds, special effects, and a few things totally out of this world!

INSTRUMENT & HEADPHONES

First connect the unit to an AC receptacle for power. Plug your instrument into the Instrument Input jack located on the front panel. Plug a set of headphones into the Headphone Output jack on the front panel. Adjust your listening level with the Stereo Master Level control.

INSTRUMENT & GUITAR AMP

Plug your instrument into the Instrument Input jack located on the front panel. Connect a cable from your guitar amp input to the Instrument Level/(-)10dB Output jack. Turn the SGX-2000 on first and then turn on your guitar amp. TURN DOWN THE LEVEL OF YOUR AMP before you play! Adjust your levels accordingly. If you are clipping your amp, back off on the Output Level of the SGX-2000.

INSTRUMENT & POWER AMP

Plug your instrument into the Instrument Input jack located on the front panel. Connect a cable from your power amp to the Left Main Output (Line Out) jack. If your power amp is stereo, connect the left and right inputs of the amp to the

Left and Right Main Output jacks. Turn the SGX-2000 on first then turn on your power amp. Adjust the level with the Stereo Master Level control.

INSTALLATION

The SGX 2000 may be used in a variety of setups including: direct into a power or guitar amplifier, mixing consoles with effects send and return facilities, in the effects loop of an amplifier, or mixer and in the tape loop of a home receiver.

Self contained in an all steel double high 19" rack mount case, the SGX 2000 is designed for continuous professional use. For touring rack applications, care should be taken to support the units rear if the rack might be subjected to mechanical shock.

NOTE: The front panel may bend if no rear support is provided. Mounting location is not critical, but for greater reliability we recommend that you not place the unit on top of power amps, tube equipment, or other sources of heat.

CONNECTIONS

All audio connections to the SGX 2000 are made at the rear of the unit via professional 1/4" mono phone jacks or XLR connectors. The MIDI connections are accomplished via five pin "DIN" jacks on the rear panel. A 2.1mm female connector is the intended plug to access the 9 volt DC output.

POWER

This device is AC powered via a standard 3 conductor grounded power cable. Plug into any standard AC receptacle. We recommend the use of a surge protector to decrease the chance of equipment damage due to voltage surges or spikes on the line. For your own safety as well as the safety of others, do not remove the ground pin of the cable. Refer to the rear panel or the specifications for proper operating voltages.

INPUTS:

There are a two inputs available for use on the SGX 2000.

INSTRUMENT INPUT

An Instrument input is located on the front panel. Plug a guitar directly into the jack with a standard 1/4" cable.

LINE INPUT

Line inputs are located on the rear panel. If you are using a mono source to the rear panel Line inputs, use the Left (Mono) jack. True stereo processing is accomplished by using both inputs in a left/right application. Use the Line input for sending "hotter" signals to the SGX 2000.

OUTPUTS:

Four different outputs are available for use.

1/4" OUTPUTS

Use the 1/4" Instrument Output to send your signal to a guitar amp. There are two line level outputs. Use the 1/4" mono Line Out jacks to send your final signal to amplifiers, mixers, or recorders. The Stereo Master Output control sets your final level present at these jacks.

XLR OUTPUTS

The male XLR outputs are balanced outputs for use in sending your final effects signal to a mixing board. Pin 2 is hot (+), pin 3 is negative (-), and pin 1 is ground. The Stereo Master Output control does not effect the levels present at this output. Use the Mains/XLR output slider on the front panel to adjust the level at these outputs.

HEADPHONE OUTPUTS

Headphone outputs may be found on the front and rear panel. Each headphone output is a standard 1/4" stereo jack. The Stereo Master Output control sets your final level present at these jacks.

NOTES:

- 1) When a true stereo signal is applied to the inputs, the resulting output is true stereo (dry signal only). If both outputs are used with a mono input signal, a stereo image is produced.
- 2) Using one output with a mono or stereo source provides a mono signal combining the information from both outputs.
- 3) The effect output is a processed combination of both the left and right input signals.
- 4) When you use the Panner, make sure you are using both outputs (stereo out), if you're using only one output you'll get NO EFFECT! This is because the two outputs are opposite and the SGX 2000 sums the outputs, the effect signals therefore cancel each other.
- 5) The headphone outputs are individually driven with their own buffer amp.

EFFECT LOOP SEND and RETURN:

EFFECT LOOP 1

Effect Loop 1 is a mono send and return located at the end of the analog section and before the programmable seven band Equalizer. Connections are standard 1/4" mono jacks.

EFFECT LOOP 2

Effect Loop 2 is a stereo send and return located after the Mix section. Connections are standard 1/4" mono jacks.

NOTES:

- 1) When you have a device plugged into the effect loops, keep the Master Override switches on the front panel in. To switch the effect in and out, add the Patchbay algorithm to the preset.
- 2) You may use the effect send jacks in Loop 2 as "pre-fader" outputs.
- 3) Use the effect send of Loop 1 as a direct out from the "preamp" section of the SGX 2000.

MIDI OUT

The MIDI output jack is used to transmit all MIDI control information from the SGX 2000 to whichever MIDI device is next in the chain. When using the SGX 2000 with an X-15 ULTRAFOOT, connect a MIDI cable to the 5 pin MIDI IN jack on the X-15.

MIDI IN

This jack receives the MIDI signal containing the MIDI messages. It enables you to "talk" to the SGX 2000 from an external source such as an X-15 ULTRAFOOT, a computer equipped with MIDI ports and associated software or a sequencer. Any MIDI information sent to the MIDI In jack is echoed to the MIDI Thru jack. When

using the SGX 2000 with an X-15 ULTRAFOOT, connect the MIDI cable to the 5 pin MIDI OUT jack on the X-15.

MIDI THRU

A MIDI Thru jack is provided on the SGX 2000 allowing you to continue a chain of MIDI devices and let MIDI information pass "thru" the unit to the next one. Information leaving the Thru jack is a direct copy of the MIDI messages received at the MIDI In jack. The information is buffered so the integrity of the signal is not degraded when passing thru.

All MIDI Jacks are standard 5 pin DIN connectors utilizing standard MIDI connections. No phantom power is present on the unused terminals. ART recommends these unused terminals remain unused.

PWR OUT

The Power Output jack located at the rear panel provides an **OUTPUT** voltage of (+)9 Volts DC. Use this jack to power external devices requiring a wall mount adapter. The ART X-11 and X-15 can be powered with this power jack. The jack will accept a female connector with an inside diameter of 2.1mm. **Do not plug in any external power supply such as a wall mount adapter to this jack.** Doing this may cause serious damage to your SGX 2000 or quite possibly yourself!

CONTROLS AND OPERATION

INPUT LEVEL INDICATORS

Three front panel LED's indicate signal level at all times. They are labeled: PRES, NOM, and CLIP. These LED's display the status of the input signal after it has passed the Drive control, Digital Processor Input level control, Second Stage Equalizer and the programmable seven band equalizer. The bottom LED (PRES) is green and lights when a small amount of signal is seen by the SGX 2000. When you are operating with a nominal amount of signal the middle yellow LED (NOM) lights. Clipping is indicated by the top red LED (CLIP).

Adjust the input level to operate the SGX 2000 with the NOM LED lit the majority of the time. Allow for transients to light the CLIP LED occasionally.

Be sure you are not causing the SGX 2000 to clip with the front end level, analog effects and equalizer settings.

NOTE: For additional information regarding proper signal levels, refer to the Level section in Appendix A.

DIGITAL PROCESSOR INPUT LEVEL CONTROL

This slide control adjusts the amount of signal sent to the digital effects section of the SGX 2000. It is located at the end of the analog effects section after Loop 1's return. Adjust the control to light the NOM LED the majority of the time and allow for transients to light the CLIP LED occasionally. When the slider is set to the far left, signal is still sent through the processor. A hotter signal from the analog section is permitted when at this setting.

MAINS/XLR OUTPUT LEVEL CONTROL

The Output Level Control adjusts the final effect output level of the SGX 2000. With the slider fully to the left, there is no output signal present at any of the output jacks. As you move the slider to the right the output signal level of the unit increases. When the slider is fully to the right, 100% effect output is achieved. With this slider you control the level to the Loop 2 effect send and the XLR outputs, as well as to the final output section.

SEVEN SEGMENT DISPLAY

(Red Numeric Display)

The Seven Segment Display keeps you constantly informed of your Preset Number. Preset numbers are displayed from 001 to 200. When a preset is active the display is stable. A flashing display indicates you are in Edit Mode and a preset is ready to be recalled. The right decimal point will light to warn you your internal lithium battery is low and needs replacing. When using the Tuner, this display will become your tuning meter.

LIQUID CRYSTAL DISPLAY (LCD)

All information relative to a preset indicated by the Seven Segment Display is displayed in the LCD. Backlighting of the display is provided for ease of use in low light situations. The upper sixteen characters mainly display the Preset Title (name). If no title has been assigned, the display will read "<blank title>". In some cases other information will be displayed here. The lower sixteen characters display mainly the number and abbreviated description of effects stored, effects to be selected or deleted in the preset, and effect parameter information. Other information may appear here also. The view angle may be adjusted and is covered in the following section under the UTILITY function.

A user or factory preset would be displayed in the LCD like the following representation.

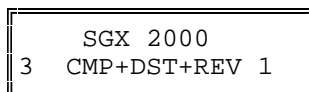

A rectangular LCD display with a double-line border. The top half contains the text "SGX 2000". The bottom half contains the text "3 CMP+DST+REV 1".

The title appears in the top half of the display. It may be up to sixteen characters long.

In the center of the bottom half of the display, three letter abbreviations of the effects in the preset appear.

The number displayed at the bottom left side of the LCD indicates how many effects are present in the preset. A number at the far right of the bottom half of the display indicates how many MIDI controllers are assigned to the preset when Performance MIDI is engaged.

A left or right arrow indicates more information is available for viewing. To view the information, press the Value button and turn the Encoder left or right.

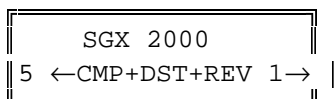

A rectangular LCD display with a double-line border. The top half contains the text "SGX 2000". The bottom half contains the text "5 <-CMP+DST+REV 1->".

LED EFFECT INDICATOR ARRAY

Under the LCD are 16 individual LED's which indicate at all times what effects are present and active in a preset. When an LED is lit, it indicates which effect is present and active in the preset you are currently using. A flashing LED indicates the effect is present in the preset but has been turned "off" from an external controller such as the X-15 ULTRAFOOT.

ROTARY CONTROLS

ENCODER

The rotary Encoder enables you to make fast and accurate changes to presets, parameters, and values accessible in each preset or function. You will notice the encoder will turn continuously in either direction. When adjusting values, you may notice they sometimes "wrap" around to the beginning or end of their range. Other times when you reach a range end you will find you must go in the opposite direction to return to the beginning. Each click of the Encoder will change the parameter value one step.

DRIVE

The Drive control sets the input level to the Preamp section. When the control is set at 0, no signal is sent to the effects. Range runs from 1 to 11.

SECOND STAGE EQUALIZATION:

The Second Stage Equalizer is a five band cut and boost equalizer that allows you to fine tune your sound from the front panel at any time without having to program or edit a preset. Cut and boost levels are plus and minus 12 dB.

THRUST

Centered at 80Hz this controls your bottom end sound.

GROWL

At 160Hz, control the upper end of your lows and lower mids to add some depth to the signal.

WARMTH

500Hz is the center point of this band. Use it to color and fill in the sound.

CRUNCH

The frequency center is 2.2KHz and allows you enhance the upper midrange.

EDGE

Add just what it says. The 5KHz frequency puts on (or takes away) the edge of the sound.

TUBE DRIVE CONTOUR

Use this control to vary the harmonic balance sound of the tube. As you turn the control from left to right the frequency goes from low to high. Accent your sound at various frequencies to bring out the extra growl, punch, or edge to your tube distortion sound. The most neutral setting for this control is 12:00.

LEFT/RIGHT BALANCE

The balance control pans the signal left or right to the headphone outputs and the Line/Amp outputs. It is the last control in the signal chain.

STEREO MASTER OUTPUT

This control sets the final output level heard at the Instrument output, Headphone outputs, and Line/Amp outputs.

PUSH SWITCHES

MASTER OVERRIDE:

EFX LOOP 1

Switches Effect Loop 1 in and out. When the switch is in, the effects loop is engaged.

EFX LOOP 2

Switches Effect Loop 2 in and out. When the switch is in, the effects loop is engaged.

NOTE: The switches must be in and you must use the Patch Bay algorithm to insert and delete outboard gear for use in a preset.

CONTROL BUTTONS

The buttons on the front panel engage or select the different functions of the SGX 2000. Modes of operation are indicated by LED's. When the LED is lit the function is active.

Ten of the control buttons serve a dual purpose. The split functions are set apart by color. While you are in the PRESET MODE (standard operating mode), all buttons labeled in purple are active. When the EDIT MODE is engaged, the numbered keypad entry buttons are used for preset effects control and utilities to be accessed. These functions are labeled in grey.

FUNCTION BUTTONS

The function buttons are those which select a particular function or feature to be executed or entered for modification. Status of the function button being in an active or inactive state is displayed by an LED next to the button identification. The function is active when the LED is lit.

PRESET

The PRESET button, when pressed, engages Preset Mode. Once this button is pressed, all 200 presets may be accessed by either the keypad or rotary encoder. When the SGX 2000 is first powered on, you are automatically in Preset Mode. Audio is being processed constantly while you are scrolling through the presets with the encoder.

Two methods of Preset selection are used, scanning (with the ENCODER) and keypad entry. Selecting a preset with the encoder is easy. Scroll through the presets by turning the knob clockwise to go forward and counterclockwise to go backwards, the preset will instantly be recalled when you stop. Each click of the encoder will change the preset value by one.

For instantaneous recall of the preset using the keypad buttons, select the exact preset number. For example; if you want preset 196, locate the buttons shown on the front panel labeled 0 through 9 (the numbers are reversed image in purple), enter 1-9-6, instantly you will see the LCD read title and preset information. If you have audio hooked up you will notice the preset has been instantly recalled. If you enter two digits, there will be a slight pause before the preset is recalled. Entering only one digit will not recall a preset.

MIX

Think of the MIX control as a three channel mixer just before the output of the SGX 2000. To set the MIX you must access and change each parameter individually. Press the MIX button until the parameter you wish to adjust is highlighted in brackets i.e. [DGFx] then change the value with the Encoder.

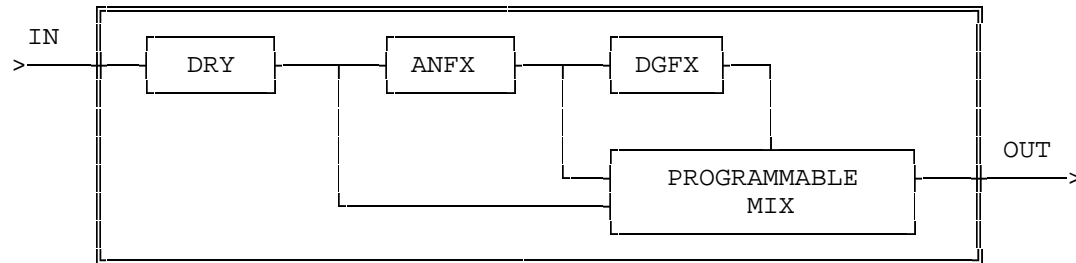

When the MIX button is pressed it engages the programmable mix function and allows you to set the level of the DRY, DIGITAL EFFECT and ANALOG EFFECT signals present at the output. The three Mix parameters are displayed as DRY, DGFx and ANFX. They control the amount of level present at the output of the SGX 2000. For example, when the Dry value is set at 100%, and the Digital and Analog Effect values are 0%, the full dry signal and nothing else is present at the output(s). A fifty/fifty mix is achieved when both the DRY and FX values are equal to each other.

You do not need to engage the PARAM button to change the Mix parameters. To disengage the MIX button, press either the Preset, Param or Value button.

DEFAULT VALUES: When you select a blank preset, Both the DGFx and ANFX levels are set at 75%, and the DRY value is set at 0%.

The programmed Mix parameters may be stored as part of the preset. To save the values in each preset, press the STORE button.

You may also control the Mix parameters with an external MIDI controller such as the ART X-15 ULTRAFOOT using the SGX 2000's Performance MIDI.

NOTE: Presets may have varying output levels due to a level control as one of their parameters. You may vary the individual effect output Level parameter to directly change the apparent mix of the effect in the preset.

PARAM

When you engage the PARAM button, effect parameters within the current preset may be viewed. The SGX 2000 automatically enters you into the EDIT mode when you select the PARAM button. Selection of the parameters may be done with the Encoder or by pressing the Param button repeatedly.

When you are in MIDI or UTILITY mode, pressing the Param button will allow you to select the available parameters with the Encoder knob or by pressing the Param button repeatedly.

While you are editing a preset, the Param button may be used as a cursor left key. Each time you press the button, the preceding parameter and value will be displayed.

VALUE

Every displayed parameter value in the SGX 2000 may be changed. When the VALUE button is engaged, you automatically enter EDIT mode and are allowed to change the parameter value using the Encoder. Press the STORE button to save any changes you make.

While you are editing a preset, the Value button may be used as a cursor right key. Each time you press the button, the next parameter and value will be displayed.

Press the Value button and turn the Encoder left or right to view effects contained in a preset. A left or right arrow in the LCD indicates more information is available for viewing.

PROGRAMMING HINT: Press the Value button to change and view the parameters then use the Encoder to set the value. This way you don't have to switch between the Param and Value buttons to edit values.

BYPASS

Engaging the BYPASS button kills the effects signal and "zeroes" (sets the bands flat) the EQ in the mix passing only dry signal to the outputs. When you first press the BYPASS button in either operating mode with a preset listed in the LCD, the display will first read [**** BYPASS ****], then it will list the preset name. The LED associated with the button will flash to indicate you are in the bypass mode. Pressing BYPASS again returns the unit to the ACTIVE mode indicated by the display [****ACTIVE****] for about two seconds and then just displaying the preset name and effects.

NOTES:

- 1) If the MIX parameters are programmed DRY = 0% and DG or ANFX = >0% and the Bypass Level Utility parameter is set to =MIX DRY LEVEL and BYPASS is initiated, no signal will be present at the outputs.
- 2) Bypass level is determined by the Bypass Level parameter discussed in the Utility section.

EDIT MODE

EDIT MODE is engaged when you press the EDIT MODE button. All creation of presets or preset parameter editing is done while in this mode. Titles, MIDI parameters, and Utilities are all accessed in Edit Mode. When in Edit Mode, all buttons associated with grey lettering are active. All the control buttons work as well.

You may access all two hundred presets for modification or use while in Edit Mode. Edit Mode is automatically entered when you press either the PARAM or VALUE buttons.

Previewing Presets

You may preview presets while in Edit Mode by engaging the PRESET button. Use the Encoder to scan through the presets. Only the titles of the presets are shown, so it is helpful to know the contents. The processed output signal is not affected. To recall the preset when you are ready, press the RECALL button. Signal is being processed through the last active preset. The reason for this is so you can set up for the next preset change when you want it to happen. When you stop scanning, the preset number in the Seven Segment Display will be flashing. If RECALL is pressed, the display will stop flashing indicating the preset is now active.

EDIT MODE CONTROL BUTTONS

ENTER

Use the ENTER button when you want to complete an action such as adding an effect to a preset. When adding an effect there is a [?] after the name, press enter if you wish to insert this effect into your chain. The prompt [?] (i.e. [ADD EQUALIZER?]) will appear in the LCD when it is necessary to press Enter to complete a task.

RECALL

The RECALL button is used to Recall presets while you are in Edit Mode. To Recall a preset (the Seven Segment Display will be flashing a Preset number), select the proper Preset and press the RECALL button. If you have been editing the parameters in a preset and wish to return them all to the original settings, press the Recall button.

ADD EFFECT

Pressing the ADD EFFECT button once opens the Add Effect function.

To add an effect to a preset, press this button and use the Encoder to select the effect you want to add to the chain. Turn the Encoder left or right to scan through your selections. Finalize the ADD EFFECT command (add the effect to the chain) by pressing the ENTER button. Doing this inserts the effect temporarily in memory. If audio is passing through the SGX 2000, you will hear the effect when you press the ENTER button. To make the effect permanent, press the STORE button.

To close the Add Effect function and escape to Edit Mode, press the button once or press the Edit Mode button.

You can preview the effects you may add to an effect. **MAKE SURE YOU ARE IN THE EDIT MODE**, press the ADD EFFECT button once, notice the lower half of the LCD shows an available effect. The effects displayed as you turn the Encoder are those available to be added to the effects chain.

It doesn't stop there! There are many sub variables of each effect to be explored. Right now let's just worry about operation and not the effects themselves. To simplify matters let's step through an example depicting the selection of four effects. We will use some of the buttons not yet explained but doing it this way will make the understanding of the programming much easier. The control buttons we use now will be defined in detail later in the manual.

Adding Effects to a Preset

When you see text within the [] brackets, it is the text as it appears in the LCD.

- Enter EDIT MODE (press the Grey button).
- Using the Encoder, GOTO preset 151 (the Preset LED should be lit).
- Press the RECALL button [<blank title>, <no effects>].
- Press the ADD EFFECT button once
- Turn the Encoder until you see [ADD:COMPRESSOR?].
- Press ENTER (you have just entered the compressor into the chain), bottom display reads [1 CMP].
- Press the ADD EFFECT button
- Turn the Encoder until [ADD:REVERB-1?] appears.
- Press ENTER (now the reverb algorithm is entered into the chain, display reads [2 CMP+REV].
- Press the ADD EFFECT button.

-Use the Encoder to select the ACU-ENV-SIM, enter it into the chain. Display should read [3 CMP+AES+REV].
-Find then add PITCH-TRANS.
*Display reads [4 CMP+AES+Ptr→]
*IF YOU WISH TO SAVE THIS CHAIN OF EFFECTS AS A PRESET YOU MUST PRESS **STORE** NOW.
-Press STORE.
*The effects you have selected are now stored in preset 151.

You may have noticed a not equals sign at the bottom left hand side of the LCD. The not equals sign indicates the changes have been made to the original values of the preset. When Store is pressed this character disappears.

REMINDER: You have not set any parameters as of yet. Don't worry, we have preselected a nominal value for each of the parameters associated with an effect as a starting point. This provides a user reference to a sound instead of starting at point zero. We feel it is useful to hear a descriptive set of parameters so you may tailor them to your own specific sound requirements. We'll look at these in just a moment as well as making a title for this preset. First, the DELETE key will be explained.

The ADD EFFECT button is also used in TITLE EDIT Mode to add characters and spaces to the title.

NOTE: Before you start building your own presets, read the section "Level Programming Hints for Building Your Own Presets" in Appendix A.

DELETE EFFECT

Pressing the DELETE EFFECT button once opens the Delete Effect function.

To delete an effect from a preset, press this button and use the Encoder to select the effect you want deleted. Turn the Encoder left or right to scan through your selections. Finalize the DELETE EFFECT command (delete the effect from the chain) by pressing the ENTER button. Doing this deletes the effect temporarily from memory. If audio is passing through the SGX 2000, you will hear the change when you press the ENTER button. Press the STORE button to make the change permanent.

To close the Delete Effect function and escape to Edit Mode, press the button once or press the Edit Mode button.

The DELETE EFFECT button is also used in TITLE EDIT Mode to subtract characters and spaces from the title.

Deleting Effects From a Preset

When you see text within the [] brackets, it is describing the text as it appears in the LCD.

Recall preset 151.

-Press the EDIT MODE button

-Press the DELETE EFFECT once. [DEL:COMPRESSOR?]

*Do you want to delete the compressor? NO.

-Turn the Encoder knob to the right until you see [DEL:ACU ENV SIM?]

*Let's delete this effect.

-Press ENTER, [3 CMP+Ptr+REV].

*The effect has been eliminated but not permanently. You will audibly hear the sound change when the effect is deleted.

*Press STORE to make this change permanent.

-Press STORE now.

With the elimination of an effect, you open up a space to insert another effect or leave things as they are.

If you press the DELETE EFFECT button and there are no effects in the preset, the display will read [DEL:NO FX TO DEL].

STORE

Any time you wish to permanently save parameter values in a preset, press the STORE button. All parameter values you have chosen will be stored into the preset as well as TITLE, MIX, and ON/OFF Controllers information. When you press the STORE button the LCD will display [PRESET STORED]. If the phrase [LOCKED/SELECT LOCATION 111-200] appears don't panic, presets 1 through 110 are factory presets and though the parameters may be changed, the new values cannot be stored without first UNLOCKING the presets (see UTILITY section).

TO DELETE A STORED PRESET, thereby releasing its memory to be used again, you must store a null preset at the preset number you wish to delete. A null preset consists of a blank title (all spaces, displayed as <blank title>) and no effects (displayed as <no effects>). Factory Preset 100 is programmed blank to make it easy to delete stored presets. Presets 111 through 200 are null when you receive your unit or after a factory reset.

REC/ARM

**YOU MUST BE USING A PRESET SET UP
FOR SAMPLING AND IN THE EDIT MODE FOR THIS FUNCTION TO OPERATE**

To reset the SGX 2000 to record a new sample, press the REC/ARM button.

While you are using any of the Sampler algorithms you will need to "reset" the record parameter to be ready to record another sample. The REC/ARM button allows you to return the Sampler to Record-Ready status. Pressing this button wipes out the existing sample.

TRIGGER

**YOU MUST BE USING A PRESET SET UP
FOR SAMPLING AND IN THE EDIT MODE FOR THIS FUNCTION TO OPERATE**

This button allows you to either record or play back a sample of the program material.

When you first recall a Sampler preset it is usually geared up and ready to record a sample. Most of the Factory Presets using the Sampler in the SGX 2000 are "record/ready". When the preset is recalled and signal is presented to the SGX 2000, recording is automatically triggered.

Now you may replay this sample as recorded at any time by pressing the Trigger button. If the PLAY parameter is set in the SINGLE position and you hit the button quickly and repeatedly, you will get that stuttering "rap" effect. The sampled sound can also be played back by a MIDI note on message, using a footswitch connected to a properly programmed REMOTE jack, or audio trigger.

You may determine the length of the sample time regardless of the Length parameter's value in the Preset with this button. Say your Length is set for 1.50 seconds and you feel the sample should end at a specific point less than 1.5 seconds. All you need to do is press the TRIGGER button once when you feel the

sample should stop. This automatically sets the Length parameter to that amount of time.

NOTES:

- 1) You will have to reset the LENGTH parameter back to its original value if the full length is required. To do this, simply hit the RECALL button. Doing this will restore the LENGTH parameter to its original value. (It is assumed the preset has been STORED)
- 2) You cannot store the audio sample in the SGX 2000 or dump it through MIDI.

TITLE EDIT

One of the displays to appear in the upper portion of the LCD is the title of the preset. There is a total of sixteen spaces with the complete ASCII character set available to use in naming presets.

To either edit the title or create a new one you must first enter the Edit Mode. To enter the Edit Mode, press the Edit Mode button. Now press the Title Edit button, [Title Edit] appears in the top half of the display and a cursor appears in the bottom half. Press the Value button and use the Encoder to select characters. If the Param button is pressed, you may move the cursor left and right with the Encoder to position it for the next character. Pressing the Value or Param buttons will move the cursor right or left one space at a time. Press the Store button to save your title.

The title will appear in the upper half of the LCD and any selected effects are in the lower half. If you wish to change the title, enter the Title Edit Mode and make the appropriate changes. Don't forget to STORE the new title.

If there are characters you wish to delete in the display use the Encoder to move the cursor and then press the ADD or DELETE EFFECT button. If you wish to delete all sixteen characters press the DELETE EFFECT or ADD EFFECT buttons sixteen times. By doing this you will eliminate any characters and have a blank display to start with.

To exit or escape from the Title Edit mode, press the TITLE EDIT button once to escape to EDIT Mode or press the EDIT MODE button.

UTILITY

The Utility button allows you to access the user settable utilities available in the SGX 2000 and view system information. Listed in this section is information regarding the variable utility parameters with their default value settings and SGX 2000 system data.

To change Utilities, first enter Edit Mode then press the Utility button. Once you are in Utility Mode you may change values by selecting the parameter and then changing the value. To do this select the parameter you wish to modify with either the Param or Value buttons. Use the Encoder to change the parameter value. (Make sure the Value LED is lit)

To view system data, press the Param or Value button until the information you're looking for appears in the display. Remember the Param and Value buttons act as a left and right cursor when they are pressed repeatedly.

You do not need to press the STORE button to save Utility parameters, it is done automatically.

To exit Utility Mode, press the Utility button to return to Edit Mode.

PROGRAMMING HINT: Press the Value button to change and view the parameters then use the Encoder to set the value. This way you don't have to switch between the Param and Value buttons to edit values.

BYPASS LEVEL

= MIX DRY LEVEL [100%]

You may globally control the level of the Bypass signal when in Bypass Mode. The Bypass Level Utility parameter overrides whatever "DRY" level is individually set in each preset. Every time Bypass is engaged, the through signal level will be whatever this value is set to. The initial default setting is 100%. When the value is set to [= MIX DRY LEVEL], the DRY level setting (from the Programmable Mix) of the individual preset will be the signal level when the preset is bypassed.

REMOTE SWITCH 1 & 2

[= BYPASS ON/OFF]

The REMOTE jacks may be programmed to either Bypass the SGX 2000, access the Increment or Decrement Preset mode, and Re-Arm or Trigger the Sampler. A footswitch and any two conductor cable is intended to be used with these jacks. If you are using an ART X-15 ULTRAFOOT, you can use the Bypass Jack feature on the X-15 to control one of the SGX 2000's Remote Jacks. A momentary (normally open) switch should be used in applications other than the X-15's bypass feature.

Use the following chart to determine how the Remote Jacks may be programmed.

#	REMOTE 1	REMOTE 2
0	BYPASS ON/OFF	BYPASS ON/OFF
1	SAMPLE-TRIGGER	SAMPLE-TRIGGER
2	INCR PROGS 2	SAMPLER-ARM
3		DECR PROGS

Either jack may be programmed for the Bypass feature, each time the footswitch is activated (hot connected to ground) the BYPASS function is accessed and acts like the Bypass button on the front panel.

The jacks may also be programmed to allow a footswitch to be used for accessing either the Trigger or Re-Arm function when using the Sampler program. Either Remote 1 or Remote 2 can be assigned as the Trigger and Remote 2 may be assigned as the Re-Arm.

These jacks may also be programmed to increment and decrement through a set of presets. Remote 1 may be set for incrementing up and Remote 2 may be set for decrementing down. For decrement program to work, you must program Remote 1 for increment. You can not program the Remote 2 jack for decrement alone.

AUTO PM DISPLAY [ALWAYS ON]

OFF, PRESET ONLY, ALWAYS ON

This utility let's you set when the LCD displays Performance MIDI messages. When set to OFF, no message is displayed when the SGX 2000 Performance MIDI messages. Preset Only allows messages to be displayed when in Preset Mode or when editing a preset. Always On means the MIDI message will be displayed whenever the SGX 2000 receives a (Performance) MIDI message.

LCD View Angle [6]

Allows the viewing angle of the LCD Display to be adjusted. You may change the LCD view angle for the best visibility. The angle may be adjusted to maximize readability of the characters from top, front or under viewing angles. When viewing from the top, use a higher number. If you are viewing the display directly from the front, use the middle numbers. Viewing the LCD when the SGX 2000 is above you, adjust the view angle to the lower numbers.

Software Version Level

Displays the software revision level currently installed in the SGX 2000. The current version as well as the date will be displayed in the LCD. This software controls the SGX 2000's functions as well as its sounds. For your convenience write the software version in the space provided on the Introduction page at the beginning of the manual.

Preset Memory Allocation

MEMORY USED= ##

AVAILABLE= ####

Displays how much user memory has been used and how much user memory is available for further storage.

This utility informs you how much User Preset Memory has been used or how much memory there is available for storing presets. When you first access user memory there are approximately 5000 bytes (5.0 Kbytes) of space available. Each time you store a preset more space is used up.

Recall Factory Preset

Allows you to recall any factory preset for comparison or editing purposes.

RECALLING A FACTORY PRESET

-Make sure you are in the EDIT Mode. (Press EDIT button if not)

-Press the UTILITY button.

-Use the Encoder or Param and Value buttons to select screen reading [HIT RECALL FOR ART PRESET #]

-Make sure the Value LED is lit.

-Use the Encoder to select the preset you want to recall, i.e. Preset 96.

-Press the RECALL button.

*Even though the title is not displayed in the LCD , the factory preset is now active, but, **IT IS NOT PERMANENT**. If you wish to make the preset permanent, you must **STORE** it. To store the preset in the first 110 locations, you must first unlock the existing preset. (See the next paragraph about unlocking a preset) If you are copying to a location above 110, press the STORE button now.

-Press STORE, the preset is now stored into the location you selected.

Preset 1-110 Locked/Unlocked

Protects the first 110 presets from being overwritten.

The factory presets may be unlocked for editing. When you set the value for Unlocked, all factory presets are unlocked and ready to edit. To relock the presets, select the Locked value when you are done editing. At first you may not want to overwrite the factory presets, so increment up to a user preset and store the new preset.

UNLOCKING THE FACTORY PRESETS

- Make sure you are in the EDIT Mode. (Press EDIT button if not)
 - Press the UTILITY button.
 - Press the Param button.
 - Use the Encoder to select the screen displaying [PRESET1...110 = LOCKED].
 - Press the Value button and use the Encoder to change the value to UNLOCKED.
- *All presets are now unlocked.** If you wish to store new information in the Factory Presets, press the STORE button.

NOTE: Remember, when you unlock a preset, ALL presets are unlocked. To prevent overwriting presets, re-lock the presets following the directions to unlock a preset, only selecting the "LOCKED" value.

MIDI

You may gain access to all MIDI parameters and their values by pressing this button. Shown here are the variable MIDI parameters and their default value settings.

Once you are in MIDI Mode you may change values by first selecting the parameter and then changing the value. To do this first press the PARAM button and select the parameter you wish to change with the Encoder. Next press the VALUE button and use the Encoder to select a new value. You do not need to press the STORE button to save the changes with one exception, it is done automatically. You need to press the Store button if you edit the On/Off status of an effect and want to make it permanent. To exit MIDI Mode, press the MIDI button to return to Edit Mode or the Edit button.

PROGRAMMING HINT: Press the Value button to change and view the parameters then use the Encoder to set the value. This way you don't have to switch between the Param and Value buttons to edit values.

MIDI Enable

PM= ON, OFF [ON]

PROG= ON, OFF [ON]

Allows you to turn on or off Performance MIDI and the Program change function independently. If you wish to use PM and not change presets, set PROG to = OFF.

MIDI Channel

OFF-16 [1]

Sets MIDI send and receive channel number.

OMNI Mode

ON, OFF [ON]

Sets MIDI OMNI mode on or off.

The SGX 2000 is shipped from the factory in OMNI mode, allowing it to receive MIDI PROGRAM numbers on any MIDI channel.

MIDI Program Table

[PROG= #]

[PRESET= #]

Allows you to edit the Midi Program Table (MPT).

Refer to APPENDIX B for examples of editing the MPT and further documentation.

FX ON/OFF ENABLE (USING X-15)
ON, OFF [ON]

When the SGX 2000 is used with an ART X-15 ULTRAFOOT, the two devices "talk" to each other. In order for the two devices to talk, Enable must be ON. The SGX 2000 enables commands to be received from the X-15 to turn the effects in the preset on or off.

NOTE: If you are not using the SGX 2000 with an X-15, set the Enable to OFF.

'ENTER' TO EDIT ON/OFF CONTROLLERS

The purpose of being able to edit the ON/OFF controllers is to allow you to change effect status without an X-15 ULTRAFOOT. You may also change the MIDI controller number assigned to the effect.

Press the Enter button and you can set up the On/Off status of an effect in a preset. The effect status is automatically set to On when you first add the effect to the preset.

If you edit the On/Off status **YOU MUST PRESS STORE TO SAVE YOUR CHANGES.**

If you do not want an effect to be active instantly when a preset is recalled set the Status to Off. When the preset is next selected, the effect will be off. Access the EFFECT MODE of the X-15 and press the associated activator pad to turn on the effect.

SWITCH #	PAD	STATUS*	MIDI CONTROLLER
0	BYPASS	OFF	MC 84:MIDI CNTLR
1	EXCITER	ON	MC 70:MIDI CNTLR
2	COMPRESSOR	ON	MC 71:MIDI CNTLR
3	DISTORTION	ON	MC 72:MIDI CNTLR
4	EQUALIZER	ON	MC 73:MIDI CNTLR
5	EXPANDER/NOISE GATE	ON	MC 74:MIDI CNTLR
6	REVERB	ON	MC 75:MIDI CNTLR
7	DELAY	ON	MC 76:MIDI CNTLR
8	PITCH TRANSPOSER	ON	MC 77:MIDI CNTLR
9	FLANGE/CHORUS	ON	MC 78:MIDI CNTLR
10	SPECIAL EFFECTS	ON	MC 79:MIDI CNTLR

*The default status is On when the effect is selected.

MIDI Event data Monitoring Mode

When you select this Mode, MIDI information is displayed in either easy to read and understand or technical terms. The LCD displays certain MIDI events as they occur, regardless of which MIDI channel is selected. Information displayed is the MIDI event itself, its attributes with a choice of display formats (in either decimal or hexadecimal base 16).

For detailed information, please refer to the MIDI DATA MONITOR section.

PRESS ENTER TO:

SEND A PRESET

Dump a single preset via MIDI to another SGX 2000 or MIDI storage device.

Sending a Preset

Transferring a **single preset** to another SGX 2000 or a suitable MIDI device is accomplished by selecting the SEND A PRESET value and pressing the Enter button.

SEND ENTIRE MIDI PROGRAM TABLE

Dump entire MPT via MIDI to another SGX 2000 or MIDI storage device.

Sending MPT Information

Transferring the **entire MPT** to another SGX 2000 or a suitable MIDI device is accomplished by selecting the SEND ENTIRE MPT value and pressing the Enter button.

SEND ALL PRESETS

Dump all presets via MIDI to another SGX 2000 or MIDI storage device.

Sending all Preset Information

Transferring **all presets** to another SGX 2000 or a suitable MIDI device is accomplished by selecting the SEND ALL PRESETS value and pressing the Enter button.

IMPORTANT NOTE For:

RECEIVING Preset and MPT Information

To dump MIDI data into the SGX 2000 from either another SGX 2000 or an external MIDI device you must make sure that the MIDI channels match. **The SGX 2000 will accept MIDI data at all times regardless of what operating mode it is in.**

PERFORMANCE MIDI [PM]

Performance Midi allows the SGX 2000 to have up to eight of its parameters per preset controlled simultaneously via MIDI. Selection of the parameter to be controlled, the actual MIDI controller, and the Low and High value of the parameter may be programmed from the front panel.

When you are in Preset or Edit Mode, the LCD will inform you of either Performance MIDI or FX ON/OFF information being received and what is being changed.

There is also a means to monitor MIDI information being sent to the SGX 2000. While you are in the PM Mode you can select the MIDI Monitor utility and verify MIDI data being sent to the device. Refer to the MIDI DataMONITOR section for additional information.

A table of MIDI controllers can be found in Appendix E, Tables and Charts.

Presets in the SGX 2000 are set up to be controlled by Performance MIDI via the ART X-15 ULTRAFOOT. See the section "Operating the Multiverb SGX 2000 with the X-15 ULTRAFOOT" further on in this manual for more information. Don't let MIDI scare you. Using Performance MIDI in an ART device is easy. In most cases (especially with an X-15) you virtually plug in and play. But, if you want to program, we've made that easy too.

Modification to select the specific values and ranges you want the parameter to cover is done by normal editing. The number displayed in the upper left corner represents the MIDI Controller you are working with. Performance MIDI has four levels of programming information associated with it broken up into 4 screens. The first screen displays the information to define what parameter the assigned MIDI controller will control.

The second screen shows which MIDI controller is being used. The LCD will display the MIDI control number and its description (i.e. MC 4 FOOT CTLR). Incidentally,

the default value is MC 4 which happens to be the Left Foot Controller on the X-15. The MIDI DataMONITOR may be selected for use in this screen to display MIDI data being sent.

The third screen displays the LOW value (minimum value) of the parameter's range. The fourth screen displays the HIGH value (maximum value) of the parameter's range. High and Low values refer to MIDI controller values. These parameters may be "swapped" to make the value change in a reverse or opposite direction.

While you are in the first screen you may also view MIDI data. Change the value until the bottom of the screen displays MIDI DataMONITOR. (turn the Encoder counterclockwise) You are allowed to change between MIDI controllers on the device you are sending MIDI data from (keyboards, X-15, etc.) and view the corresponding data in this screen. The top half of the display will show the numerical value of the MIDI data being received by the SGX 2000. Displayed in the bottom half is the actual MIDI controller being used. Use the Value Up or Down key to change the MIDI controller. When you change the controller, its MIDI data will be displayed in the top half of the LCD.

DESCRIPTION OF ALGORITHMS

The SGX 2000 offers over seventy effects selections for you to choose from. Each effect may have several types to select for specifically narrowing down the particular sound you are looking for. The algorithms are listed in seven categories in the manual. These are: Analog Effects, Signal Frequency Shaping, Swept or Modulated Effect, Natural Reverberation, Gated Reverberation, Delay, and Utility/Level.

There are some digital categories that cannot be combined together. Rather than tell you which effects cannot be combined, the SGX 2000 automatically selects (or defaults) to which algorithms may be combined and displays them in the LCD when you are "ADDING an EFFECT".

All of the analog and digital effects parameters including the Mix Control parameters are controllable via the X-15. Some parameters were specifically tuned to be used with foot controllers. Specifically, all compressor output, envelope filter tuning, and any threshold, attack, release or range parameter and the Distortion output when using TURBO, or JAZZ TUBES, SOLID WARM or TUBE STACK.

The algorithm name and abbreviation are shown in brackets [] under the effect title i.e. [EQUALIZER], [EQL]. Default settings for each parameter are shown in brackets [] at the end of the Parameter Values i.e. [0].

NOTE: When setting up your own presets, select the digital effect you want most in your effects chain first. By doing this, you are able to determine what other effects may be combined with the selected effect.

ANALOG EFFECT ALGORITHMS

COMPRESSOR

[COMPRESSOR], [CMP]

Parameters:

DRIVE: 0 to 100% in 2% increments [78]
SLOPE: 1:1, 2:1, 3:1, 4:1, 10:1, LIMIT, RVR1, RVR2 [4:1]
ATTACK: 2, 3, 4, 7, 14, 30, 50ms [4ms]
RELEASE: 200, 300, 350, 500, 750ms, 1, 2 sec [750ms]
OUTPUT: 0 to 100% in 2% increments [94%]

The compressor in the SGX has all the controls you need for dynamics processing. The Attack automatically adjusts to the audio and you can set it from 2 to 50mSec. Release is also intelligent and adjustable from 200mSec to 2 Sec. Slope is programmable from 1:1 to Limit. The drive control sets the maximum gain. Adjust the release time to set the "openness" of the sound. The faster the release the more the signal is "crushed". Slower (longer) release times give notes more sustain. Long release times maintain the natural envelope of the input while a slower release brings up the gain to bring out the nuances at low levels. Use the Attack to choose the pick attack you need. Short attacks tend to give a "tight" , well controlled sound. Longer attacks add punch to the source. Set the final output level of the Compressor with the Output parameter.

NOTES:

- 1) If you add the compressor and set its' slope to 1:1 you get a programmable level control on the input of the analog signal chain. This works great as a variable distortion drive, or volume pedal effect.
- 2) The Compressor can be re-patched and replace the input signal on the "DRY" portion of the mix. This is great for getting a compressed guitar mixed with distorted guitar. Just add the PATCH BAY to the preset and set DRY= POST CMP to use the compressor as the DRY signal.

EXPANDER

[EXPANDER], [EXP]

Parameters:

RANGE: OFF, 0 to 100% in 2% increments [75%]
RATIO: OFF, 1:1.5, 1:1.8, 1:2, 1:2.5, 1:3, 1:4, 1:5 [1:3]

The expander is an extension of the compressor. (You don't need the Compressor in the effects chain for the Expander to work) Use the expander to reduce the noise the compressor may bring up. Adjust the Range control for the audio threshold level. This level is where the expander will affect the signal. Setting the slope below 3:1 allows notes to tail off smoothly and still remove noise. Greater slopes act more like a noise gate, chopping off the noise below the threshold setting. Since the detector is shared with the compressor, attack and release time parameters affect the expander performance. Longer attacks mute the initial attack of a note. Extremely long attacks can sound like a reverse envelope effect if only the expander is applied.

DISTORTION

[DISTORTION], [DST]

Parameters:

DST: OFF, TURBO TUBES, PSYCHO TUBES, OVERDRV TUBE, JAZZ TUBES,
SOLID SUPER, SOLID WARM, TUBE CLEAN, TUBE STACK [TURBO TUBES]

DRIVE: 0 to 100% in 2% increments [50%]

BITE: 0, 1, 2, 3, 4, 5, 6 [3]

OUTPUT: 0 to 100% in 2% increments [100%]

The 12AX7 tube used in the SGX 2000 is a twin pentode tube. What this means is there are essentially two tubes enclosed in one case. We use these two tubes together to produce different types of overdrive and distortion. There are four separate solid state circuits used to create an overdrive or distortion algorithm. In all, there are eight different distortion algorithms to choose from. Two are tube only, these two algorithms are "Overdrive Tube" (overdrv tube) and "Tube Clean". Two are solid state only and are called "Jazz Tubes" and "Solid Warm". The four stacked versions of tube and solid state together are: "Turbo Tubes", "Psycho Tubes", "Solid Super", and "Tube Stack". Use the Drive parameter to adjust the amount of gain used to drive either the tube or solid state circuitry. As you increase the drive, you increase the amount of distortion. The Bite parameter allows you to add presence and high end to the distortion. Output sets the final output level of the distortion circuit.

NOTES:

- 1) The Tube Drive Contour control on the front panel does not do anything when a tube distortion is not part of the effect chain.
- 2) The Bite parameter of the distortion effect does not do anything when a tube only distortion is present in the effects chain.
- 3) You may also use the DRIVE control on the front panel of the SGX 2000 to adjust the amount of saturation in the distortion.
- 4) Use the Tube CONTOUR control to adjust the Response/frequency/characteristic sound of the tube.

HARMONIC EXCITER

[HAR-EXCITER], [EXC]

Parameter:

RANGE: OFF to 100% in 3% increments [34%]

Use the Harmonic Exciter when you want to enhance or add life to an instrument and add clarity to vocals in a mix. As you turn the Range parameter up, the effect the exciter has on the signal increases.

The exciter in the SGX 2000 is integrated within the distortion section. Located between the tube and solid state distortions circuits, different distortion types are enhanced in extraordinary ways. Applied to Turbo Tubes for instance, it adds thickness to distortion. It acts like a "harmonic superdrive" control with Solid Super. Add it with Solid Warm type and it brings out the growl of the distortion.

ENVELOPE FILTER

[ENVLP FILTER], [ENV]

Parameters:

TYPE: = ULTRA, SUPER, MEDIUM, NARROW, X15 SWP, RVRS LO, RVRS HI, OFF [ULTRA]

THRESH: = 0 to 100% in 3% increments [90%]

ATTACK: = 360, 180, 120, 80, 50, 40, 30ms [40ms]

TUNE = 120 to 3200Hz (64 steps) [1079 Hz]

The Envelope Filter algorithm provides seven filter sweep ranges producing a variety of WAH WAH effect sounds sweeping from low to high and high to low. Set the Type to select the sweep width needed. Ultra has an extremely wide range, Super a standard sweep, Medium a little less and Narrow for a tight frequency range. When you select the X15 Swp, the SGX is to be controlled by the Ultrafoot. The RVRS settings sweep from high frequency to low frequency. The HI is a wide sweep and the LO is a narrow sweep. Set the Threshold parameter to trigger the sweep. Attack sets how fast the filter responds to playing. Adjust your frequency sweep window with the Tune parameter.

NOTES:

- 1) The actual input level after the Drive control is used to trigger the envelope filter.
- 2) Using a Distortion with the Envelope Filter adds some harmonic interaction to the sound.
- 3) The release time is fixed at 200ms.
- 4) If you use the X-15 Ultrafoot, you must assign a Performance MIDI controller to the Threshold parameter.

NOISE GATE

[NOISE GATE], [NGT]

Parameter:

RANGE = OFF to 100% in 3% increments [50%]

The Noise Gate is located last in the analog effects chain. Its one parameter, Range, sets the threshold point of when the gate kicks in, shutting off the signal. As the Range parameter value increases, the SGX 2000 is allowed to gate off higher signal levels.

NOTE:

The Noise Gate uses the input signal level to determine if it is opened or closed.

SIGNAL FREQUENCY SHAPING ALGORITHMS

EQUALIZER (SEVEN BAND EQUALIZER)

[EQUALIZER],[EQL]

Parameters:

40Hz (+/-) 2,4,6,9,12,15 dB [0]

100Hz (+/-) 2,4,6,9,12,15 dB [0]

250Hz (+/-) 2,4,6,9,12,15 dB [0]

640Hz (+/-) 2,4,6,9,12,15 dB [0]

1.6KHz (+/-) 2,4,6,9,12,15 dB [0]

4KHz (+/-) 2,4,6,9,12,15 dB [0]

10KHz (+/-) 2,4,6,9,12,15 dB [0]

The Seven band Equalizer is located directly after the Digital Processor Input slide control. Each band may be adjusted plus or minus 15dB in twelve steps. Use the Equalizer to change the curve of the signal before it is sent to the digital effects.

Levels of the bands are displayed in the LCD both by a complete bar graph display of all bands and the actual frequency with level setting. The LCD will display information like the following diagrams.

EQUALIZER GRAPHICS DISPLAY

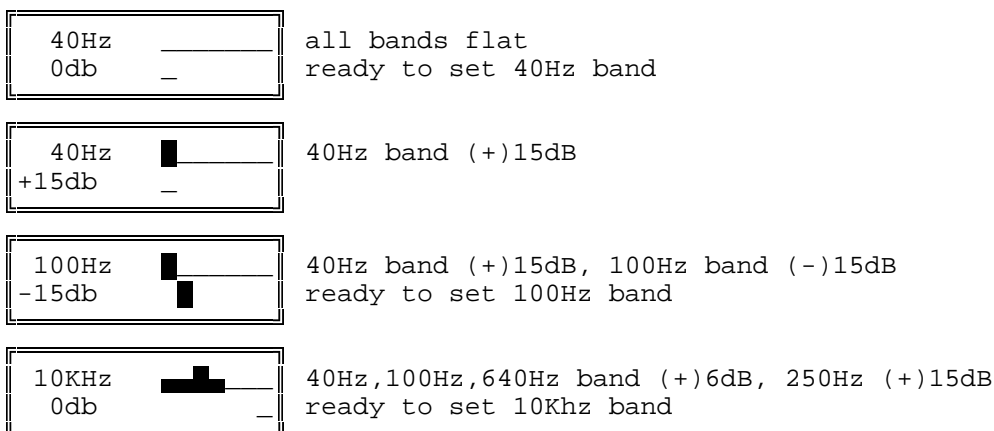

ACOUSTIC ENVIRONMENT SIMULATOR

[ACU-ENV-SIM], [AES]

Parameter:

OFF, DEAD ROOM, HEAVY CARPET, WOOD/RUG MIX, DRAPE/CARPET,
 WOOD + TILE, PEWS/PEOPLE, WOOD BAFFLES, LT FLOOR RUG, CEILING DRAPE, STONE
 CEILING, WALL DRAPES, NATURAL WOOD, OPEN AMBNCE [OFF]

The Acoustic Environment Simulator (AES) allows you to simulate adding in baffles or sound absorption materials to alter the high end response of your signal. Of course this is a logical as well as necessary option, the SGX 2000 reproduces sound to 20KHz, well above normal natural ambiance.

Better than an equalizer, the AES program actually knocks out frequencies over the entire spectrum, simulating real world acoustics. AES lets you warm up a room or hall, deaden drums, soften a vocal, sizzle your ears off with presence, or just make your material sound natural.

NOTE: When using AES alone, be sure to control its output level in the Mix with the ANFX parameter. Due to its location in the signal chain, if you are only using AES and no digital effects you must use this parameter to bring out the simulations at the output.

LOW PASS FILTER
[LOW-PASS], [LPF]

Parameter:

HF-CUT: = THRU, 17.8K, 15.8K, 14.1K, 12.6K, 11.2K, 10.0K, 8.91K, 7.94K, 7.08K, 6.31K, 5.62K, 5.01K, 4.47K, 3.98K, 3.55K, 3.16K, 2.82K, 2.51K, 2.24K, 2.00K, 1.78K, 1.58K, 1.41K, 1.26K, 1.12K, 1.00K, 891Hz, 794Hz, 708Hz, 630Hz. [THRU]

There is one algorithm defining the Low Pass Filter. This effect will always be placed at the front of the digital effects chain so as to tailor the frequency response of the effect and not the final product which should be further modified at the board. Thirty possible selections of roll-off frequencies are provided.

PITCH-TRANSPOSER
[PITCH-TRANS], [Ptr]

Parameters:

:TYPE= OFF, SMOOTH, NORMAL, QUICK [SMOOTH]
:PITCH = (-)12 to (+)12 half steps in 1 half step increments [0]
:FINE = (-)4.00 to (+)4.00 half steps in 0.06 (six cents) increments [0.00]
:BASE KEY = OFF, 1 through 127 (key note on) [OFF]
:REGENERation = 0 to 100 percent in % increments [0%]
:LEVEL = 0 to 100 percent level in % increments [100%]

Pitch Transposing or pitch shifting can be used to develop helpful second harmonies or other effects for vocals, instruments and even mixed material.

There are three "types" of pitch transposing to choose from in the SGX 2000, Smooth, Normal and Quick. Smooth relates directly to processing and splicing the signal more slowly, resulting in a cleaner more precise sound. Use the Smooth setting when you are shifting pitch more than a fifth with lower frequency inputs such as the low strings on a guitar. Normal should be used for virtually all other applications of pitch shifting. There is a little less delay than the Smooth setting and qualitative processing is achieved. When you select the Quick setting, a shorter delay time is used causing faster splicing.

Generally you should use the Normal Type for most applications. If you encounter problems relating to delay time, use the Quick Type and if detuning becomes a problem, use the Smooth Type.

The PITCH control lets you set the range of pitch change in half steps. The FINE parameter lets you adjust the pitch in 6 cent intervals. Use the fine tune parameter to create or adjust micro pitch shifting or fat chorusing effects.

REGENERation is useful when you stack the Pitch Transposer with the MONO DDL algorithm. Each time a repeat is done it is shifted up or down by the pitch selected.

The Base Key parameter should be used when triggering the Pitch Transposer from a MIDI keyboard. The amount of pitch shift may be set by MIDI Note On messages. The values selected in the Base Key parameter correspond to the MIDI Key Number. Example: BASE KEY = 60, (= middle C) if a D above middle C is played, the shift amount will be set to (2). If base key is set to OFF, Note On messages will not affect pitch.

SWEPT OR MODULATED EFFECT ALGORITHMS

FLANGER

[FLANGER], [FLA]

Parameters:

:TYPE= FLANGER OFF, POST; REVERB, INV L, INV R, INV L+R,
PRE; REVERB, INV L, INV R, INV L+R [POST REVERB]
:WIDTH= 0 to 100 percent in % increments [71%]
:SPEED= .04Hz to 27.3Hz [0.84Hz]
:REGENeration= 0 to 100 percent in % increments [76%]
:LEVEL= 0 to 100 percent in % increments [100%]

A wide range of flanging effects may be created with the SGX 2000. Normal and inverted flanging is available to you. An inverted flanger type reverses (inverts) one output from the other. The inverted types are listed as INV L and R, where L and R are Left and Right.

The base delay of the Flanger is set and the sweep WIDTH and SPEED is user controlled. REGENeration may be adjusted to vary the "strength" of the processed signal. The output level of the FLANGER may be adjusted to control it's "depth" in the preset. When the Flanger TYPE= POST the flanger is positioned last in the chain. This is to assure that maximum effect and presence is maintained in all effects combinations. Using Flanger TYPE= PRE positions the FLANGER in parallel with any Reverb or DDL effect. By positioning the Flanger like this, the processed signal is not delayed or reverberated before it is flanged.

CHORUS

[CHORUS], [CHO]

Parameters:

:TYPE= OFF, POST, PRE, [POST]
:WIDTH= 0 to 100 percent in % increments [34%]
:SPEED= .04Hz to 27.3Hz [0.84Hz]
:DELAY= 0 to 47ms in 1 ms increments [30]
:LEVEL= 0 to 100 percent in % increments [100%]

Chorus may be used to thicken or sweeten the final processed sound. It is created by sweeping a comb filter through a base delay time and generally using between a 30 to 60 percent mix between the dry and wet signal. The base delay time plays an important role in the perception of the effect. Longer base delays are more preferable to give a deep rich sound to vocals and guitars, while shorter base delays are used for more delicate enhancement purposes. The width plays an important role in the range of perceived effect and is best used in conjunction with the speed parameter. Like the FLANGER, the effect type may either be POST or PRE located in relation to reverb or delay. The output level of the CHORUS may be adjusted to control it's "depth" in the preset.

PANNER

[PANNER], [PAN]

Parameters:

:MOD % =0 to 100 percent in % increments [100%]

:SPEED= .04Hz to 27.3Hz [2.16Hz]

MIDI-PAN

[MPN]

Parameter:

POSITN = 0 to 127 in 1 step increments [64]

Panning automatically pans the audio image from the left to the right in the stereo sound field. By varying the MODulation, you adjust the "depth" into the stereo field (how far left and right you go). The SPEED merely controls the rate at which you do so.

When you choose the Panner, the signal is automatically panned by the SGX 2000 from left to right at a depth and speed you set. Choosing the MIDI-PAN allows you to assign a MIDI Controller to change the signal's position with an Expression Pedal or other MIDI device.

NOTES:

1) When using the panner, you should always set your MIX DRY level to 0%. This ensures complete signal panning from left to right (full right = full signal... no signal left and vice versa).

2) When you use the Panner, make sure you are using both Line outputs or the Headphone outputs, if you're using only one Line output or the Instrument output you'll get NO EFFECT!, because the two outputs are summed canceling the effect.

TREMOLO

[TREMOLO], [TRM]

Parameters:

:MOD % =0 to 100 percent in % increments [100%]

:SPEED= .04Hz to 27.3Hz [2.16Hz]

Tremolo creates an amplitude modulating effect at the output. The actual output signal level is being cut in and out at a certain rate. Use the MOD parameter to control the depth of the Tremolo. Re-create the effect found on vintage as well as current guitar amplifiers.

NATURAL REVERBERATION ALGORITHMS

REVERB-1

[REVERB-1], [REV]

Parameters:

:TYPE= HALL-1, ROOM-1, PLATE-1, VOCAL-1, OFF [HALL-1]

:IN = PRE DDL, POST DDL [PRE DDL]

:DECAY = 0 to 25 seconds in varying increments [2.4s]

:HFDAMP = 0 to 50 percent in % increments [14%]

:POSITN= FRONT to REAR in % increments [83%]

:LEVEL = 0 to 100 percent in % increments [100%]

REVERB-2

[REVERB-2], [REV]

Parameters:

:TYPE= HALL-2, ROOM-2, PLATE-2, VOCAL-2, OFF (REVERB-1 TYPES are also available)
[HALL-2]
:IN = PRE DDL, POST DDL [PRE DDL]
:DECAY = 0 to 25 seconds in varying increments [2.4s]
:HFDAMP= 0 to 50 percent in % increments [14%]
:POSITN= FRONT to REAR in % increments [83%]
:LEVEL = 0 to 100 percent in % increments [100%]

REVERB-3

[REVERB-3], [REV]

Parameters:

:TYPE= HALL-3, ROOM-3, PLATE-3, VOCAL-3, OFF
(REVERB-1 and REVERB-2 TYPES are also available) [HALL-3]
:IN = PRE DDL, POST DDL [PRE DDL]:DECAY = 0 to 25 seconds in varying increments
[2.4s]
:HFDAMP= 0 to 50 percent in % increments [14%]
:POSITN= FRONT to REAR in % increments [67%]
:DIFFUS= 40 to 100 percent in four % increments [100%]
:LEVEL = 0 to 100 percent in % increments [100%]

REVERB-1 algorithms are best used when you are using multiple effects. They have less density and are more suited to effects where the reverb is not the main effect but is used for presence.

REVERB-2 algorithms use more delay and have a higher complexity than the REVERB-1. REVERB-3 algorithms are the most complex and dense. Always use REVERB-3 when building "reverb only" programs.

The TYPES of reverb are what make up the reverberant space. The smallest space is the Plate. Generally this reverberant sound is used for tight and harsh sounding reverb. Room and Vocal types are the next size spaces. They tend to be a little looser allowing the sound to "bounce" around more adding color to the sound. The Hall types are the largest allowing you to fill in the spaces with reflections and build up density.

Once you decide what type of space is required, the length of DECAY is selected. Generally the size of the space is proportional to the time it takes the signal to decay. The larger the space, the longer the decay. Don't stick to this rule! Many quality sounds are made by bending the rules and allowing for creativity.

Since reverberant spaces tend to boost high frequencies the High Frequency Damping (HFDAMP) parameter allows you to damp out frequencies as natural damping would in a reverberant space. Putting up baffles, carpeting, drapes or wood in the space is simulated. The higher the value, the more damping.

Position (POSITN) puts you as a listener where you would hear the sound if you were in the space. Front positions you closest to the initial signal so you here more 1st reflections and the reverberant decay is in the background. As you position yourself more towards the Rear, you "mix" the initial sound to reverberant sound ratio. At the Rear of the space, you hear the signal decay with all the reflections and very little initial sound.

Diffusion (DIFFUS) is how much the sound bounces around in the space. The lower diffusion % is looser and the smoothest at 100%.

LEVEL adjusts the effect level of the preset.

GATED REVERBERATION ALGORITHMS

GATE-VERB-1

[GATE-VERB-1], [GAT]

Gated Reverb

Parameters:

:TYPE= SLOPE-1, FLAT-1, RVRS-1A, RVRS-1B, OFF

[SLOPE-1]

:IN = PRE DDL, POST DDL [PRE DDL]

:DECAY = 0 to 0.25 seconds in :DECAY = 0.05 to 0.25 ms in 5 ms increments [0.25s]

:DIFFUS= 60 to 100 percent in four increments of 20% [100%]

:LEVEL = 0 to 100 percent in % increments [100%]

GATE-VERB-2

[GATE-VERB-2], [GAT]

Gated Reverb

Parameters:

:TYPE= SLOPE-2, FLAT-2, RVRS-2A, RVRS-2B, OFF [SLOPE-2]

:IN = PRE DDL, POST DDL [PRE DDL]

:DECAY = 0.05 to 0.40 seconds in 5 ms increments [0.40s]

:DIFFUS= 60 to 100 percent in four increments of 20% [100%]

:LEVEL = 0 to 100 percent in % increments [100%]

GATE-VERB-3

[GATE-VERB-3], [GAT]

Gated Reverb

Parameters:

:TYPE= SLOPE-3, FLAT-3, RVRS-3A, RVRS-3B

[SLOPE-3]

:DECAY = 0.05 to 0.40 seconds in 5 ms increments [0.40]

:DIFFUS= 60 to 100 percent in four increments of 20% [100%]

:LEVEL = 0 to 100 percent in % increments [100%]

Both GATE-VERB-1 and GATE-VERB-2 have forward and reverse gated reverb algorithms which are not quite as dense or complex as those found in the GATE-VERB-3 algorithms. For an equal decay, GATE-VERB-2 is denser than GATE-VERB-1. The decay times found in GATE-VERB-2 are longer. When used in a stack of effects these gated sounds will fill in nicely. If you choose to use these effects alone, they will be loose and moderately sparse. By varying the amount of diffusion you directly affect the tightness (or looseness) of the sound. High diffusion equates to a tighter effect.

GATE-VERB-3 algorithms are the most complex and dense. Always use GATE-VERB-3 when building "reverb only" programs. The difference between normal reverb decays and decays when a gated program is the normal decay gradually fades into nothing while the gated decay ends in an abrupt manner. The most interesting gated program is the flat setting. Here there is no decay but the equivalent of a short burst of sound.

DELAY ALGORITHMS

TAP'D-DDL-S

[TAP'D-DDL-S], [DDL]

Tapped Digital Delay - Short

Parameters:

:TYPE:= FLAT-1m, FLAT-1s, RVRS-1m, RVRS-1s, SLOPE1m, SLOPE1s, (E)
FLAT-2m, FLAT-2s, RVRS-2m, RVRS-2s, SLOPE2m, SLOPE2s, (S)
FLAT-3m, FLAT-3s, RVRS-3m, RVRS-3s, SLOPE3m, SLOPE3s (L) [FLAT-1m]
:TAPS= 1 to 7 in one step increments [2]
:DELAY* = 0 to 960ms [100ms]
increments:5ms;0-350, 10ms;350-700
20ms;700-960
D-FINE* = 0 to 50ms in 1ms increments [0ms]
:REGENeration = 0 to 100 percent in % increments [76%]
:LEVEL= 0 to 100 percent in % increments [100%]
*Total delay possible is 1010ms.

TAP'D-DDL-L

[TAP'D-DDL-L], [DDL]

Tapped Digital Delay - Long

Parameters:

:TYPE:= FLAT-1m, FLAT-1s, RVRS-1m, RVRS-1s, SLOPE1m, SLOPE1s, (E)
FLAT-2m, FLAT-2s, RVRS-2m, RVRS-2s, SLOPE2m, SLOPE2s, (S)
FLAT-3m, FLAT-3s, RVRS-3m, RVRS-3s, SLOPE3m, SLOPE3s (L) [FLAT-1m]
:TAPS= 1 to 7 in one step increments [3]
:DELAY* = 0 to 1100ms [240ms]
increments:5ms;0-350, 10ms;350-700
20ms;700-1000, 50ms;1000-1100
D-FINE* = 0 to 50ms in 1ms increments [0ms]
:REGENeration = 0 to 100 percent in % increments [76%]
:LEVEL= 0 to 100 percent in % increments [100%]
*Total delay possible is 1150ms

There are three levels of tapped delays in the SGX 2000. These are what we call Even (E), Shortened (S), and Lengthened (L). (1's are Even, 2's are Shortened, 3's are Lengthened) Even means that the delay taps are at evenly spaced intervals. Shortened means that as the taps approach the set delay, the intervals are closer together. As the taps approach the set delay in the Lengthened mode they are farther apart. In the types you will see an [m] and an [s], the [m] means mono and the [s] signifies stereo. The mono tapped delay has its left and right taps at the same delay points where the stereo taps are staggered. When using the stereo tapped delays the first right tap is half the delay time before the first left tap.

There also are three slopes used in the tapped delays, Flat, Reverse and Forward. Flat has a flat linear response. Reverse increases in amplitude exponentially as the signal approaches the end. Forward exponentially decreases in amplitude as the signal approaches its end point.

TYPE 3 taps are dense and full. Use the longer tapped delay programs to add some expansiveness to short reverb patches. Use the longer tapped delays especially the Sloped algorithms to create a fundamental front end reverb.

REGEN-DDL-S

[REGEN-DDL-S], [DDL]
Regenerated Digital Delay - Short

Parameters:

:DELAY* = 0 to 960ms [100ms]
increments:5ms;0-350, 10ms;350-700
20ms;700-960
D-FINE* = 0 to 50ms in 1ms increments [0ms]
:REGENeration = 0 to 100 percent in % increments [76%]
:LEVEL= 0 to 100 percent in % increments [100%]
*Total delay possible is 1010ms.

Since this delay algorithm has the characteristic of being in parallel with a reverb program if used with one, it can be used to add a small amount of depth, or wrap-around effect to the sound. A "hard reverb" effect may be achieved by using longer delay and a moderate amount of regeneration. Tonal sounding drones may be found using short delay and large amounts of regeneration.

REGEN-DDL-L

[REGEN-DDL-L], [DDL]
Regenerated Digital Delay - Long

Parameters:

:DELAY* = 0 to 1100ms [200ms]
increments:5ms;0-350, 10ms;350-700
20ms;700-1000, 50ms;1000-1100
D-FINE* = 0 to 50ms in 1ms increments [0ms]
:REGENeration = 0 to 100 percent in % increments [50%]
:LEVEL= 0 to 100 percent in % increments [100%]
*Total delay possible is 1150ms

Use this algorithm for the same reasons and applications as the short Regen-DDL, only using longer delay times.

STEREO-DDL-S

[STEREO-DDL-S], [DDL]
Stereo Digital Delay - Short

Parameters:

:DLY-L* = 0 to 1100ms [80ms]
:L-FINE* = 0 to 50ms in 1ms increments [0ms]
:DLY-R* = 0 to 1100ms [110ms]
:R-FINE* = 0 to 50ms in 1ms increments [0ms]
increments:5ms;0-350, 10ms;350-700
20ms;700-1000, 50ms;1000-1100
:REGEN = 0 to 100 percent in % increments [76%]
:HFDAMP = 0 to 100 percent in % increments [0%]
:LEVEL= 0 to 100 percent in % increments [100%]
*Total possible delay is 1150ms

STEREO-DDL-L

[STEREO-DDL-L], [DDL]
Stereo Digital Delay - Long

Parameters:

:DLY-L=* 0 to 1300ms [250ms]
:L-FINE* = 0 to 50 ms in 1 ms increments [0ms]
:DLY-R* = 0 to 1300ms [125ms]
:R-FINE* = 0 to 50ms in 1ms increments
increments:5ms;0-350, 10ms;350-700
20ms;700-1000, 50ms;1000-1300
:REGEN= 0 to 100 percent in % increments [45%]
:HFDAMP= 0 to 100 percent in % increments [0%]
:LEVEL= 0 to 100 percent in % increments [100%]
*Total possible delay is 1350ms

You can split image or create alternating regenerative patterns between the left and right outputs using Stereo Digital Delay. The ability to set separate delay times for each channel enables you to do this. When used in conjunction with the Flanger, Chorus or Panner, spatial effects are the result. Regeneration is derived from the left channel.

When longer delay times are needed, use the STREO-DDL-L algorithm. Set both Left and Right Delay times at 1300 ms for maximum delay output with no separation. You may also operate this effect in mono.

SAMPLER-S

[SAMPLER-S], [SMP]
Sampler-Short

Parameters:

STAT=REC-RDY, PLAY, IDLE [REC-RDY]
RECORD=AUTO, MANUL, MIDI [AUTO]
PLAY=SINGLE, PUNCHIN, MIDI, REPEAT, AUDIO [SINGLE]
LENGTH= 0.02 to 1.30 seconds in 20ms increments [1.3s]
START= 0 to 100ms in 1ms increments [5ms]
LEVEL=0 to 100 percent in % increments [100%]

SAMPLER-L

[SAMPLER-L], SMP
Sampler-Long

Parameters:

STAT=REC-RDY, PLAY, IDLE [REC-RDY]
RECORD=AUTO, MANUL, MIDI [AUTO]
PLAY=SINGLE, PUNCHIN, MIDI, REPEAT, AUDIO [SINGLE]
LENGTH= 0.02 to 1.58 seconds in 20ms increments [1.58s]
START= 0 to 100ms [5ms]
LEVEL=0 to 100 percent in % increments [100%]

SAMPLER+PTR

[SAMPLER+PTR], [SPT]

Sampler Plus Pitch Transposer

Parameters:

STAT=REC-RDY, PLAY, IDLE [REC-RDY]

RECORD=AUTO, MANUL, MIDI [AUTO]

PLAY=SINGLE, PUNCHIN, MIDI, REPEAT, AUDIO [SINGLE]

LENGTH= 0.02s to 1.25 in 20 ms increments [1.25s]

START= 0 to 100ms [5ms]

PITCH= (-)12 to (+)12 half steps in 1 half step increments [0]

FINE=(-)4.00 to (+)4.00 half steps in 0.06 cent increments [0.00]

BASE KEY=OFF, 1 through 127 (key note on) [OFF]

LEVEL= 0 to 100 percent in % increments [100%]

Status always informs you of the state the Sampler is in. After a sample has been taken, status is Idle waiting either to be Re-Armed or played.

Record lets you choose how you want to sample the sound. Auto is signal activated, the sampler will start recording as soon as signal is applied to the SGX 2000 and the GREEN LED is lit. Manual is operator activated, the sampler will start recording when you press the trigger button or use a footswitch with the Remote jack. MIDI is MIDI activated, the Sampler will start recording when the SGX 2000 receives any Note On message.

Play lets you select how the sample is played back when triggered. Single plays back once per trigger, Repeat keeps repeating the sample until triggered again, and MIDI plays back when any Note On message is received. Punchin lets you insert a sample into the current signal stream. When you trigger the sample, the current signal is cut out and only the sample is heard. If you have a preset set up with the Punchin value, set your Dry level in the Mix to 0%. Audio triggers the Sampler to playback when the YELLOW LED is lit. Before the sample can be retriggered the YELLOW LED must go out.

Length is the amount of time you have to record (and playback) a sample. If you find you've recorded too much, you may eliminate the unwanted end signal by reducing the Length parameter.

Start allows you to trim the beginning of the sample removing annoying clicks, unwanted sample material or dead space.

Level sets the amount of signal level coming out of the Sampler.

Use the Short Sampler, [SAMPLER-S] when you want to combine a sampled sound with reverb. The algorithms from reverb groups one and two are available. Every time the sample is played back it will be subjected to the reverb parameters you have set.

The Long Sampler [SAMPLER-L] should be used when you require one and a half seconds of sampling time.

You should use the Sampler with Pitch Transposer [SAMPLER+PTR] algorithm when you want to shift the pitch of the sample during playback. Each time the sample is played back it will be subjected to the pitch parameters set.

NOTES:

- 1) The Low Pass filter [LPF] acts as a high frequency rolloff to the signal before it is sampled and may be added to all three algorithm choices.
- 2) You may program the Remote Jacks to access the Trigger and Re-Arm feature.
- 3) BASE KEY in the SAMPLER + PTr algorithm has no effect on triggering samples.
- 4) You cannot store an audio sample.
- 5) See APPENDIX A, for more information regarding the SAMPLER.

SYSTEM CONTROL/LEVEL ALGORITHMS

PATCH BAY

[PATCH BAY], [PBY]

Parameters:

DRY = INPUT, POST CMP [INPUT]

LOOP1 = OUT, IN [IN]

LOOP2 = OUT, IN [IN]

Use the Patch Bay to route the input "dry" signal either pre or post compressor to the programmable Mix control. When set to Input, only "dry" signal taken directly after the Drive control is sent to the Programmable Mix [DRY] parameter. When set to Post CMP, the signal first passes through the compressor and then sent to the Programmable Mix [DRY] parameter.

To insert the Effects Loops into the preset, add the Patchbay. By adding the Patchbay, you control whether the effect plugged into the effects loop is "in" or "out" when the preset is selected. Setting the Loop = to IN allows the effect to be in when the preset is recalled. You may assign a MIDI controller to change the value between IN and OUT.

NOTE: The Master Override switches on the front panel must be "In" for the Loops to be active in a preset.

DIGITAL CONTOUR

[DIG CONTOUR], [DGC]

Parameters:

HI/LO SPLIT, HIGH to DGFX, LOW to ANFX, BYPASS [BYPASS]

TUNING = 110Hz, 160Hz, 230Hz, 350Hz, 560Hz, 1KHz, 2KHz [350Hz]

Adding Digital Contour to a preset allows you to control how the audio signal is split into separate low and high frequency paths. Use this to keep your sound distinct rather than losing or burying it. When using Compression, Distortion, EQ, Reverb, and Swept effects, it's a good idea to include the Digital Contour algorithm. Set the Tuning parameter to select the crossover point of the signal.

[HI/LO SPLIT] sends only the low frequency material to the analog Mix Output and the high frequency to the digital effects. If you are using distortion, this will give your lower end a ballsy sound and keep your digital effects from being muddled.

[HIGH to DGFX] sends just the high frequency material to the digital effects. This keeps unwanted low frequency material from muddying up your digital effects.

[LOW to ANFX] sends only the low frequency material to the analog Mix Output. Sending the higher frequency signal material to the digital effects such as reverb or delay will keep the decays crisp and clean sounding.

PROGRAMMABLE LEVEL

[PROGR LEVEL], [LVL]

Parameter:

MASTER = 0 to 100% in 2% increments [93]

By adding Programmable Level to the effects chain, you are capable of setting the master output level of each individual preset easily. The Programmable Level algorithm controls the amount of signal level after the Digital Processor Input slider and before the Digital Contour.

TUNER

[TUNER], [TNR]

Parameters:

TYPE = BASS, GUITAR [GUITAR]

REFRNC (guitar) = OFF, E 82, A 110, D 147, G 196, B 247, E 330, A 440, AUTO [OFF]

(bass) = OFF, B 31, E 41, A 55, D 73, G 98, C 131, A 440, AUTO [OFF]

DETUNE = (-)2.00 to (+)2.00 in 0.04 (four cent) intervals [0.00]

LEVEL = 0 to 100% in 2% increments [0%]

Type allows you to choose what instrument you are going to tune. There are two choices, Bass and Guitar. When you choose an instrument, the Reference frequency (Refrnc) parameter defaults to either Guitar or Bass tuning frequencies. The strings start low and go high. The frequency A 440 is included for tuning keyboards, or checking the intonation of your neck. When you select Refrnc to equal Off, it allows you to access the preset and display the preset number instead of [- - -]. The Tuner at this point is inactive, you must change the Refrnc parameter to a string value to activate the Tuner. When you set the Refrnc parameter to Auto, tuning is simplified even more. Auto enables the SGX 2000 to know which string you are trying to tune and automatically switch the Reference parameter to the correct string/frequency. The Auto range has a frequency window of 2.5 halfsteps.

Detune will let you change the reference frequency A 440 plus or minus 2 half steps. This allows you to detune up to 50Hz. As a rule of thumb 4 cents, displayed as [0.04] equals 1Hz. So, to detune A440 to A435 you would set the Detune parameter to [-0.20]. To detune a full half step, set the Detune parameter to = [1.00] (plus or minus). Level sets the signal output level of the Tuner in a preset.

NOTES:

- 1) If you do not wish anyone to hear you tune up when you realize you're out of tune, set the Tuner Level and the ANFX level of the Mix to [0%] in the preset.
- 2) If you want signal to pass through the tuner, set the Tuner Level and the ANFX Level to the desired output level.
The tuner is designed to respond to open string tuning only, no harmonics. For best results, tune your guitar in the position you will be playing in. Plucking the string at or near the 12th fret will help the tuner lock on to the signal.
- 3) Accuracy of the SGX 2000 Tuner is better than .5 cents!
- 4) 100 cents = 1 semitone = 1 halfstep.

Factory Preset 113 [GUITAR TUNER X15] is set up to work instantly with an X-15 to tune a guitar. Select preset 113 and use the left pedal to select the string you wish to tune. If you do not have an X-15, enter Edit mode and press the Value button. Select which string you wish to tune with the Encoder.

Select preset 005 [AUTO GUITAR TUNER] for quick tuning while on stage. This preset is set up to auto detect which string you want tuned.

How to use the Tuner:



Watch the LED window display: With the REFRNC parameter set to the string you wish to tune, pluck the string. Give the unit a chance to "lock-on" to the signal, the unit will make frequency measurements as long as the green Pres LED is lit. After each pluck of the string, allow the unit to lock-on to the signal before attempting continued tuning. The most accurate tuning will be obtained by adjusting the string after it has "sung" for some time while dying out.

If insufficient audio level prevents the unit from making measurements the LED window will look like Display 1 .

When you are more than a half step (100 cents) sharp or flat the LED window will look like Display 2 or 3.

Within 100 cents of the correct pitch, the LED window displays the number of cents sharp or flat in the rightmost 2 digits. See Display 4 and 5.

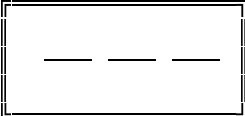
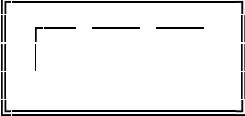
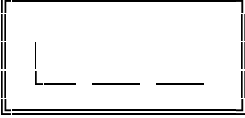
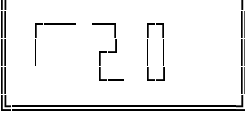
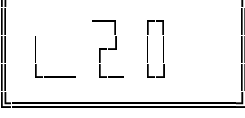
When you are within 2 cents (sharp or flat) of the correct pitch, your LED window will look like Display 6. The two digits may be 00, 01, or 02 and you'll be in tune. As long as the | is displayed, you're in tune.

DISPLAY 1:		INSUFFICIENT INPUT SIGNAL
DISPLAY 2:		MORE THAN A HALF STEP SHARP
DISPLAY 3:		MORE THAN A HALF STEP FLAT
DISPLAY 4:		SHARP 20 CENTS
DISPLAY 5:		FLAT 20 CENTS
DISPLAY 6:		IN TUNE

MIDI DATA MONITOR

The SGX 2000 has 2 MIDI features collectively called "MIDI DATA MONITORing". These include the Performance MIDI(tm) Data Monitor, referred to as [DM] and the MIDI EVENT MONITOR, referred to as [MEM].

PERFORMANCE MIDI Data Monitor [DM]

This Data Monitor allows a user, while viewing a Performance MIDI (PM) controller's definition under Edit Mode, to see the data associated with the MIDI event selected to control an effect's parameter unaltered. A user having selected MOD WHEEL to control reverb decay time can optionally see the MOD WHEEL values themselves without having it affect reverb decay time. This feature serves as a MIDI setup debugging tool. You can determine if the MOD WHEEL is in fact being seen by the unit.

Enter DM Mode while in Edit Mode, press the Param button and go to the screen displaying [#1 IS CONTROLLING] in the top half. Press the Value button, and turn the Encoder left until the display reads [MIDI dataMONITOR] on the bottom. Press the Param button and move the Encoder one click to the right, the screen defines the MIDI controller used in the preset. Move the Encoder one click to the right, [#n DATA IS] is displayed. This line will show the actual data value associated with the selected MIDI event, as they are received. The space after "DATA IS" stays blank until the unit receives the selected event. The bottom line is identical to the 2nd window bottom line and you are able to select MIDI events in this window by using the Value button and the Encoder, without having to go back to the 2nd window. Whenever a new MIDI event is selected under DM, the portion of the window that displays the actual value is blanked until the new MIDI event data is received.

Example of PERFORMANCE MIDI Controller Definition Screens

Screen #1	Screen #2	Screen #3
<pre>#1 IS CONTROLLING MIDI DataMONITOR</pre>	<pre>#1 CONTROLLER IS MC 4:FOOT CTLR</pre>	<pre>#1 DATA IS MC 4:FOOT CTLR</pre>

MIDI EVENT MONITOR [MEM]

The MIDI EVENT data MONITORING MODE (MEM) feature is one of the parameters available while in MIDI Mode. This mode shows the user an "English-ed" version of certain MIDI events as they occur, regardless of MIDI channel. The information displayed shows the type of MIDI event and its attributes with a choice of display formats, called "English-ed" or "Raw Data". Each of these formats offers a choice of display numeric info in either decimal or hexadecimal (base 16, the format for experienced MIDI users). To select the Event Monitor, enter Edit Mode then MIDI Mode. Press the Param button and use the Encoder to select [MIDI EVENT data MONITORING MODE].

```
MIDI EVENT data
MONITORING MODE
```

The unit is now ready to display the following of MIDI Events:

MIDI CONTROLLERS:

All, 0 thru 120 (MOD WHEEL, MIDI CONTROLLER #001 etc).

CHANNEL VOICE events:

NOTE ON, NOTE OFF: Actual note names and accidental (Sharp only) shown.
POLYPHONIC AFTERTOUCH (Note names and accidental).
CHANNEL PRESSURE AFTER TOUCH
PITCH BEND CHANGE

Other MIDI events monitored:

PROGRAM CHANGE

MEM does NOT monitor:

System Exclusive messages
Channel Mode messages (All Notes Off etc.)
Real Time messages (Timing Clock)
System Common messages (MIDI Time Code)

Each MIDI event is displayed depending on which display mode is active. The default display mode is "English-ed" decimal. Using the VALUE Up/Down keys will move through the two display modes (with two numeric formats each). The latest event is reformatted accordingly. In the case of NOTE ON/OFF and POLYPHONIC AFTERTOUCH events, the musical note associated with the event has its note name displayed next to the numeric value of the note.

Examples of Screen Displays for MIDI CONTROLLER #4 FOOT CONTROLLER

"ENGLISHed" Mode

Decimal

```
MIDICTL=176 CH01
FOOTCTLR=004:127
```

"RAW DATA" Mode

Decimal

```
176 004 127
FOOTCTLR=004:127
```

Hexadecimal

```
MIDICTL=B0h CH01
FOOTCTLR=04h:7Fh
```

Hexadecimal

```
B0h 04h 7Fh
FOOTCTLR=04h:7Fh
```

Examples of Screen Displays for MIDI EVENT PITCH BEND

"ENGLISHed" Mode

Decimal

```
PTCHBND=225 CH02
LSB=000 MSB=064
```

"RAW DATA" Mode

Decimal

```
225 000 064
LSB=000 MSB=064
```

Hexadecimal

```
PTCHBND=E1h CH02
LSB=00h MSB=40h
```

Hexadecimal

```
E1h 00h 40h
LSB=00h MSB=40h
```

Examples of Screen Displays for MIDI EVENT PROGRAM CHANGE

"ENGLISHed" Mode

"RAW DATA" Mode

Decimal

Decimal

```
PGMCHNG=192 CH01
PROGRAM #069
```

```
192 069
PROGRAM #069
```

Hexadecimal

Hexadecimal

```
PGMCHNG=C0h CH01
PROGRAM #45h
```

```
C0h 45h
PROGRAM #45H
```

DISPLAYED TEXT	ACTUAL NAME	MIDI CONTROLLER #
-----	-----	-----
MODWHEEL	Modulation Wheel	001
BREATH	Breath Controller	002
FOOTCTLR	Foot Controller	004
PORTAtim	Portamento Time	005
DATA msb	Data Entry MSB	006
MAIN VOL	Main Volume	007
BALANCE	Balance	008
PAN	Pan	010/0Ah
EXP CTLR	Expression Controller	011/0Bh
GENERAL1	General Purpose #1	016/20h
GENERAL2	General Purpose #2	017/11h
GENERAL3	General Purpose #3	018/12h
GENERAL4	General Purpose #4	019/13h
DAMP PED	Damper Pedal	064/40h
PORTAMEN	Portamento	065/41h
SOSTENUT	Sostenuto	066/42h
SOFTPEDL	Soft Pedal	067/43h
HOLD 2	Hold 2	069/45h
GENERAL5	General Purpose #5	080/50h
GENERAL6	General Purpose #6	081/51h
GENERAL7	General Purpose #7	082/52h
GENERAL8	General Purpose #8	083/53h
ExtFXdpt	External Effects Depth	091/5Bh
TREM dpt	Tremolo Depth	092/5Ch
CHOR dpt	Chorus Depth	093/5Dh
CELESdpt	Celeste Depth	094/5Eh
PHASEdpt	Phaser Depth	095/5Fh

NOTES:

- 1) The only accidental displayed is the sharp, "#".
- 2) PROGRAM CHANGE events: The actual program number specified in the event is a 0-origin number and will be displayed as such, consistent with the unit's display of program numbers under the MIDI PROGRAM TABLE MIDI menu item. A MIDI program change event to program #5 is actually a message to go to (excluding mapping via MIDI PROGRAM TABLE) to program #6!
- 3) MIDI CHANNEL#s: The display "CHnn" (where "nn" is the channel# associated with a particular MIDI event) shows the channel# as a 1-origin number. A MIDI event with a channel# value of 2 will display as "CH03"!

4) If, while in MEM mode, the unit is enabled to respond to PROGRAM CHANGE events (and those events occur on the same channel on which the unit is listening) and such an event occurs which causes the unit to switch to a preset that has the SAMPLER effect, a message may display for a few moments indicating that the SAMPLER is RECORD-READY. When this message (or others) is finished, the display will return to the most recent event and display mode.

MISCELLANEOUS INFORMATION

About the Presets

The presets of the SGX-2000 are grouped together for various sounds and applications. Locations 1 thru 21 are set up for instant use with a guitar, try presets 22 thru 30 with an X-15 ULTRAFOOT and guitar for foot control of the effects. Check out presets 31 thru 45 for delay effects such as chorus and flange. Presets 46 thru 49 have no digital effects, just raw tube and solid state power. The rest of the presets are a collection of killer and clean sounds, special effects, and a few things totally out of this world!

The presets were all configured with all front panel controls at center value.

Battery Backup

When power is terminated to the SGX 2000, the edited MPT as well as the last preset used and the MIDI Channel will be active when the unit is next powered up. Memory retention is expected to last four years. Should you encounter memory loss, contact our service department.

Low Battery Indicator

The life of the internal lithium battery is approximately four years. If you see the right decimal point illuminated in the seven segment display, it is indicating the voltage of the lithium battery is low.

Software Revision Level

There is a way to correctly identify the software version residing in the unit. While in Edit Mode, press the Utility button, then press the Param button. Turn the Encoder until the current version as well as the date is displayed in the LCD. The SGX 2000's software is contained in a socketed EPROM. This software controls the SGX 2000's functions as well as its sounds.

User Registration Card

Be sure to fill out the USER REGISTRATION CARD with this manual and send it in to our Customer Service Department. Doing this will insure that you are notified of important information regarding your SGX 2000. Please be sure to write in your serial number.

Factory Reset

There is a Factory Reset sequence which will reinitialize the SGX 2000 to ALL of its original values. Be sure you have either downloaded or kept a written record of the Presets since they will be eliminated. To perform a Factory Reset, press and hold the **PRESET, 0/ENTER, and 4/MIDI** buttons simultaneously.

Other Means of Bypassing the SGX 2000

Bypassing the unit via MIDI may be done by easily. Since the SGX 2000 has the capability of MIDI BYPASS, all you need to send is an on/off control message. The SGX 2000 bypass default setting is MIDI Controller # 84.

X-15

If you are using your SGX 2000 with the ART X-15 ULTRAFOOT, refer to APPENDIX G in this manual or to the X-15 manual for any detailed information you may need.

Customer Service

You may contact ART's Customer Service Department between the hours of 9:00 AM and 4:00 PM Eastern Time Monday through Friday. The Customer Service Department will answer technical questions about ART products and provide information concerning service (in the unlikely event you need it).

ART SGX 2000 SPECIFICATIONS

Total Presets..... 200
Factory Presets.....115
User Memory Locations..... 90

Dynamic Range>90dB Typical

Equivalent Input Noise.....-100dBv

Operating Level.....+16dBV max

Input Impedance:

Line.....1M ohm
Instrument.....470K ohm
Loop Return.....1M ohm

Output Impedance:

Line.....1K ohm
Balanced Line.....600 ohm
Inst.....2K ohm
Headphone.....47 ohm
Loop Send.....1K ohm

Mechanical.....3.50"H X 19"W X 10"D, all steel case

Weight.....12lbs (5.5Kg)

Power Requirements.....105-125 Volts AC, 60Hz, Internal Fuse
240ma @ 117VAC, 28.1W

(Export unit configured for destination country.)

MIDI Receive Channel.....1-16, OMNI (all), Off

MIDI Programs.....May be assigned to any Preset #

Connections.....In/Out 1/4" 1/4" Stereo Headphone, XLR

..... MIDI: IN, OUT, THRU, 2.1mm (+)9 VDC OUTPUT

ART retains a policy of constant product improvement. Specifications are subject to change without notice.

Designed and manufactured in the United States of America.

Contact Information

Applied Research & Technology, Inc. (ART)

215 Tremont Street

Rochester, New York 14608

USA

(716) 436-2720
(716) 436-3942 (FAX)
artroch@aol.com
<http://www.artroch.com>

APPENDIX A HELPFUL HINTS

Building Your Own Presets

Building presets is easy, really. Don't let all those effects possibilities scare you. What we suggest is to start by modifying existing presets. By doing this, you'll become familiar with how presets are built, what's in them and most importantly the level settings. Don't forget, one of the most important parts of the preset are the Mix parameters. Find a few presets that initially sound usefull to you. Copy these presets to a block of blank locations. (i.e. start at preset 130 and work up) Press the Value button and use the Encoder to view the effects. Or, press the Param button and use the Encoder to view the parameters and their values.

To modify the preset change the values you think should be different or wonder about the difference between "types" (distortion, slope, reverb, etc.). To change a value, press the Value button until the parameter you wish to change is displayed in the LCD. Use the Encoder to change the value.

To add or delete effects from the preset, press the Add or Delete Effect button and use the Encoder to make your selection. Press the Enter button to finalize the command.

When you're done press the Store button to save your changes. Don't forget to give your preset a name of it's own. You can name it anything, but, a title describing the sound of the preset will help you remember what it's going to be used for. Press the Title Edit button while the Edit Mode LED is lit to change the name.

If you need more information about the buttons and their use, check the Table of Contents for their location and go to that section in the manual.

Level Programming Hints When Building Your Own Presets

The SGX is capable of an incredible range of effects. One of the reasons is the fact that every effect is strong enough to stand by itself. Combining effects is one of the most powerful facets of the SGX. In combining effects you can mistakenly amplify the raw noise of a guitar to unnecessarily high levels. This is where you can get into trouble.

Constructing presets for the SGX is very easy. You simply add effects, set the mix and you have usable presets. The difference between usable and great presets is in the tweaking of parameters and a few design insights.

Here are some recommendations for things to try:

1) Keep the Input Drive control up as far as it will go without clipping the unit. This will optimize your guitar to the SGX.

2) Make sure the NOM LED (yellow) is lit while playing. The Clip LED may occasionally light. If the NOMinal LED is not lit, the unit may sound noisy. If the level is too low, increase the Compressor Output or add the Programmable Level effect and set it to 100%.

3) Whenever you add an effect that has gain (ie. compressor or distortion), add the Expander first and if the noise is still high, add the Noise Gate also.

4) Limit the maximum gain in a preset. If you add compressor and distortion, you can have as much as 90dB of gain! This will bring up the noise of the guitar to ear shattering levels. If you are going for the effect of a distorted, compressed signal, back off on distortion drive to less than 50%. This will provide the same effect and less noise.

5) Set the Programmable EQ ([EQL]) for the overall EQ curve for the preset. Use the Second Stage EQ (front panel knobs) to fine tune these settings. Keep the boost/cut below 6dB. Limit the use of 10KHz boost since this brings up noise, and not many harmonics are present here. If you can, trade off 10KHz boost for 4KHz boost. Reduce boost in the EQ sections. Instead of boosting level in bands, use cut in adjacent bands instead, it works just as well!

6) Reduce compressor or distortion drive if using both effects in a preset. Reduce the input drive control and never turn it up all the way. Reduce the master output level if possible.

7) Add the expander to reduce the gain at low level.

8) Try keeping the MIX settings to 75% to reduce noise and leave you room for adding gain if required.

8) Use as little DIGITAL ([DGF]) effects level in the MIX as possible. Keep the digital effects output levels to 100% and the MIX setting 75% or less.

Using Your Head (Amplifier)

The SGX 2000 is a working preamp, so is the head in your guitar rig. Using the two together proves "two heads are better than one"! Even though the SGX 2000 is not a power amp, combining it with your existing setup greatly expands your sound capability.

Setup 1: Guitar/SGX 2000/Amp

Guitar into the Instrument Input of the SGX 2000, Instrument Output to your clean channel input of the head. Use the clean channel so you can use the SGX 2000's front panel controls to modify your sound not your amp. Initially, set all the head's tone controls to flat. After the SGX is set up, slight tonal modifications can then be done with your head's tone controls. Set the Mix parameters in each preset to control the signal level to your head. This will allow you to have the rig's master volume set and all you have to do is change presets for louder or softer levels.

Setup 2: Guitar/Amp/SGX 2000 in Amp Effects Loop

Guitar into the dirty channel of the head, amp effect send to Line input (Left Mono) of the SGX, Line out (Left) to the amp effect return. When using this configuration, you will be using the drive characteristics of your head and accenting them with the SGX 2000. Make sure your input level to the SGX is "hot" enough. The Drive control on the front panel will probably be set to 8 or above depending on the amplifier used.

Miscellaneous Suggestions

It is not suggested to use a microphone plugged directly into the SGX 2000. Even though the device will function properly with some types of microphones you may encounter level mismatch or level problems. Some type of preamplifier is required since the input sensitivity of most microphones is less than -40dB.

For the effects that have a LEVEL control parameter, use this control to adjust for depth and apparent mix level for each preset.

To control the overall output level of the SGX 2000 via MIDI, assign an external MIDI controller to change the Master parameter in the Programmable Level algorithm. You are able to do this by adding a MIDI controller to your preset and setting the values accordingly.

Signal level required to trigger the AUTO Record of the Sampler is to input enough signal to light the GREEN LED.

Signal level required to trigger the AUDIO Play of the Sampler is to input enough signal to light the YELLOW LED. Use the front panel Digital Input slider to adjust the threshold level of the audio trigger.

Insert a volume pedal in Loop 1 and use it to control the signal level to your processor.

If you are using the Instrument Input on the front panel you clip the SGX 2000 easily, use the Line Input (L mono) on the rear panel.

APPENDIX B
EXAMPLES

COPYING A PRESET

You may copy a preset from any location into another easily. (If you want to copy a factory preset into another factory preset location, you must first Unlock the destination preset.) To copy a factory preset into one of the 90 user presets follow these steps.

- Enter EDIT Mode.
- Select the preset you want copied by pressing the Preset button and using the Encoder to dial it up.
- Press the RECALL button.
- Use the Encoder to select the preset location you are copying to i.e. Preset 111.
- Press the STORE button.
- *The preset has now been copied and stored to the new location.

FACTORY RESET

There is a Factory Reset sequence which will reinitialize the SGX 2000 to ALL of its original values. Be sure that you have either downloaded or kept a written record of the Presets you want saved since they will be eliminated. To perform a Factory Reset you must press and hold the **PRESET, 0/ENTER and 4/MIDI** buttons simultaneously.

EXAMPLE 1:

Editing the MPT from the SGX 2000 front panel controls.

In this example, we will edit the MPT so when MIDI numbers 1 and 2 are received, SGX 2000 PRESETS 60 and 151 will be recalled. It is assumed that the SGX 2000's MPT has not been edited.

- Make sure you are in the EDIT Mode. (Press EDIT button if not)
- Press the MIDI button.
- Press the Param button.
- Turn the Encoder until you see in the LCD:

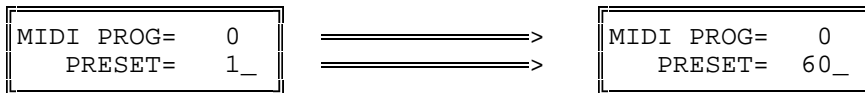

- Press the Value button and use the Encoder to change the number to 60.
- Press the param button twice, press the Value button and turn the Encoder 1 click.
- Press the Value button twice and use the Encoder to change the number to 151.

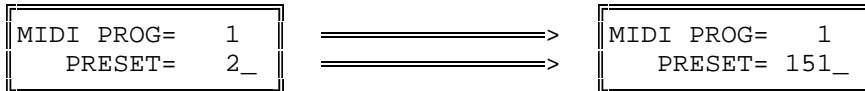

- Exit MIDI mode by pressing the MIDI button once.

You may assign any preset # to any program # including a preset to a multiple of program #'s. To test the reassigned numbers, use a MIDI device to recall the presets. Your reassigned presets should be recalled.

NOTE: Don't forget, many foot pedals are configured for their preset 1 to recall MIDI program 0. This example allows for this and preset 1 is recalled when the foot pedal preset 1 is recalled.

EXAMPLE 2:

Editing the MPT with a keyboard or external controller.

Using this method of editing, you select the desired patch on the keyboard or foot pedal, and then select the desired PRESET on the SGX 2000 for that sound. You can do this while you are listening to the SGX 2000.

When used with a keyboard or other device which sends MIDI PROGRAM CHANGE messages, MPT editing is simplified. We will edit the MPT for MIDI numbers 2 and 3, to recall presets 96 and 1. Once again it is assumed the SGX 2000 has not had its MPT edited.

The keyboard/controller MIDI OUT must be connected to the SGX 2000's MIDI IN jack. The MIDI channel on the SGX 2000 must be set to the same channel of the sending device, or the SGX 2000's OMNI mode must be ON.

- Make sure you are in EDIT Mode. (Press EDIT button if not)
- Press the MIDI button.
- Turn the Encoder until you see in the LCD:

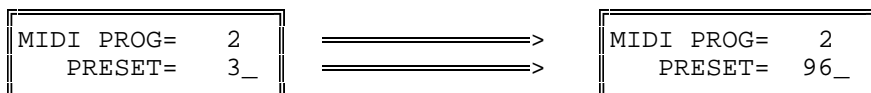

-Select a patch on the keyboard or MIDI foot pedal so [MIDI PROG= 2] is displayed (select either preset #1, 2 or 3). If the MPT has never been edited, [PRESET= 3_] should be in the lower half of the display.

*The patch that causes [MIDI PROG= 2] to appear in the display is usually the second or third patch of the lowest numbered bank if the keyboard has banks of patches.

- Use the Encoder to select preset 96.
- With the keyboard change the MIDI PROGram number to 3.
- Set the PRESET to = 1.

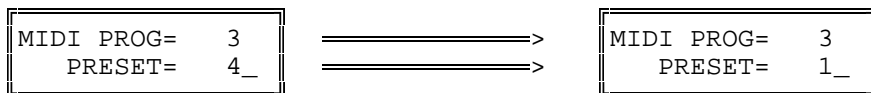

You may continue to program each of the keyboard's patches (say there are 64) in this manner assigning any preset # to the patch. In the previous examples four of the MPT entries were edited. You may edit the entire MPT if desired.

INCREMENT PROGRAM

If you do not have access to a MIDI controller and you wish to change between PRESETs easily, you may want to edit the MPT for incrementing through a sequence of presets. Example 3 illustrates how this is done.

The sequence programmed in Example 3 may be accessed from the front panel. A more useful way of using a programmed sequence is to access the sequence using the REMOTE jack and a momentary footswitch. To access these presets we must program the REMOTE jacks to increment or decrement through the programs. Example 4 describes how program the REMOTE jack to sequence through the ten presets set up in Example 3 with a footswitch. Example five shows how to program the REMOTE jack for normal bypass operation.

EXAMPLE 3

Setting up a preset sequence including a bypass preset.

If you need to change between presets quickly without scanning or MIDI, this procedure will be to your advantage. As in the other examples, editing the MPT is the key. In this example we will edit the MPT to sequence through ten presets. Ten is not the limit. You may program a sequence of 127 presets if you wish. These presets will be in the order: 60, 151, 96, 1, 151, 35, 1, 69, 100 and 61. Notice that we repeated some presets and included preset 100 which is set up from the factory as a bypass preset (no effects stored in it). Remember you can assign any preset to a MIDI number including using a preset at multiple locations. Using an empty preset as a bypass enables you to select no effect eliminating the need to bypass the unit from the front panel and then continuing on with an effect preset next in the chain. NOTE: If your Mix is set for only 100% EFX, no signal will pass through the SGX 2000.

- Make sure you are in EDIT Mode. (Press EDIT button if not)
- Press the MIDI button.
- Press the Value button, use the Encoder to change the display to:

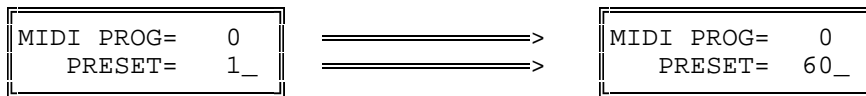

- change between the upper and lower lines, changing the values as needed.
- *MIDI program #'s will be 0 thru 9.
- *follow the procedure in Example 1 if you're stuck!

EXAMPLE 4

Programming the REMOTE jack for Incrementing Programs

Program the REMOTE 1 jack on the rear panel so you may use a footswitch to increment through a desired set of presets, operate as a normal bypass jack, or trigger the Sampler. Remember, you may only increment up when using a footswitch and the sequence cycles through to the beginning.

- Make sure you are in EDIT Mode. (press EDIT button if not)
- Press the UTILITY button. Change the display to read [REMOTE SWITCH 1] in the top half and [= BYPASS ON/OFF] in the bottom half.
- Press the Value button.
- Use the ENCODER to change the number to 9.
- *You have just programmed the SGX 2000 to sequence through the ten presets set in Example 3 when using a momentary footswitch plugged into the REMOTE 1 jack.

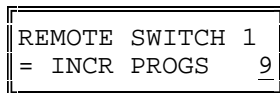

NOTE: To change this to decrement presets, program the REMOTE 2 jack for decrement following the above example.

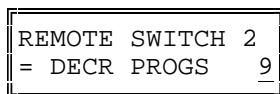

EXAMPLE 5

Adding Performance **MIDI** to an existing preset.

In this example we are going to add **PM** to preset 32, "GO TO YOUR ROOM". The effect parameter we will control is: LVL:MASTER, the master level of the preset. The intended controller will be MC 4, Foot Controller. Now when the MIDI controller is used, the Master Level will change from 0% to 100%.

- Recall preset 32.
- Press the EDIT button.
- Use the Encoder to scroll up to preset 120.
- Press the Store button.
- *You've just copied 32 to location 120.
- Press the ADD EFFECT button and turn the Encoder until you see [ADD:MIDI CONTRL?].
- Press the ENTER button.
- *You have just added a MIDI controller to the preset.
- Press the Param button four times.
- Press the Value button.
- Use the Encoder to select [LVL:MASTER= 93%]
- Press the Value button again, DON'T CHANGE THIS VALUE.
- Press the Value button again. DON'T CHANGE THIS VALUE
- Press the Value button one more time!!!!
- DON'T CHANGE THIS SETTING EITHER.
- Press the STORE button.

You now have edited a Factory Preset for **PM** control. You may edit any existing preset to be controlled by **PM**. Remember to UNLOCK the preset to STORE your changes and then re-lock the presets.

The MIDI controller assigned in this preset is MC 4, a foot controller. If you are using your SGX 2000 with an ART X-15 ULTRAFOOT, the left pedal will control the master level of the preset.

APPENDIX C
SGX 2000 MIDI MESSAGES

The SGX 2000 responds to the following messages:

Program change:

Cxh ddh

x = channel number 0h to Fh for channels 1 to 16

dd = program number 0h to 7Fh or 0 to 127

If the channel the SGX 2000 is set to is not off and the channel matches (either it is the same number or OMNI is on), then the unit will look up the preset in the MIDI Program Table (MPT) and recall the corresponding preset.

Channel Mode message for OMNI on/off

Bxh 7Ch 0h : OMNI Mode Off

Bxh 7Dh 0h : OMNI Mode On

x = channel number, 0h to Fh for channels 1 to 16

If the channel matches the units's channel number, it will set the OMNI mode accordingly. The current OMNI mode does not affect this message, the channel must match regardless of current OMNI mode.

SYSTEM EXCLUSIVE MESSAGES

message format:

general: <System Exclusive Status> <ART ID> <channel>
 <product ID> <message ID> <message...> <EOX>

in hex: F0h 1Ah 0xh 12h <message ID> <message...> F7h

F0h - System Exclusive status byte.

1Ah - ART manufacturer's ID number.

0xh - channel number, 0 to 0Fh.

12 - SGX 2000 product id code.

F7h - End Of exclusive status byte.

Message ID values >= 40h are requests. A request is a message that when received by the SGX 2000 causes a message to be sent by the SGX 2000.

0x is the channel number, 0 to 15 (00h to 0Fh). To the user, the channel number is displayed as 1 to 16.

Internally, presets are numbered 0 to 199. When a preset number is displayed, it is shown as 1 to 200. Any messages that refer to the SGX 2000 preset number refer to the internal number, 0..199. Preset numbers are referenced in message with 2 data bytes, least significant 7 bits, then most significant bit in the lsb of the next byte. Example: preset 1 on the LCD is referenced with 00h 00h, and preset 200 is referenced with 47h, 01h.

When channel number is OFF and a front panel command for a dump is processed, the SGX 2000 sends a message coded for channel 1 (the lowest channel number).

DETAILED DESCRIPTION OF MESSAGES

Set Bypass OFF: F0 1A 0x 12 03 00 00 F7

Set Bypass ON: F0 1A 0x 12 03 00 01 F7

This allows remotely setting the state of BYPASS in the SGX 2000 without affecting anything else in the unit.

MIDI controller messages may also be used to turn Bypass ON/OFF. The default value is MIDI controller number 84.

Request DUMP all presets: F0 1A 0x 12 4B F7

LOAD all presets: F0 1A 0x 12 0B <many bytes> F7

Dumps all presets in preset number order. No compression of the data is done.

Request MPT table: F0 1A 0x 12 4C F7

Set MPT table: F0 1A 0x 12 0C <128 * 2 bytes> F7

For each MIDI program number there is a corresponding SGX 2000 preset number. Each entry (internally) is 0..199 and is sent as 2 bytes. First the least significant 7 bits, then the msb. This is done for each of the 128 MIDI program numbers.

When FX ON/OFF Enable is ON, you may use MIDI controller 84 to activate MIDI Bypass.

If you find you require additional MIDI technical information, please contact our Customer Service department at (716) 436-2720.

APPENDIX D

MIDI Implementation Chart

ART SGX 2000 model 500; Date: OCTOBER 1991; VER 1.0

Function		Transmitted	Recognized	Remarks
Basic Channel	Default Channel	X	1-16	note 1
	Channel	X	1-16	
Mode	Default	X	Mode 1,3	note 1
	Messages	X	OMNI ON/OFF	
	Altered	X	0	
Note Number	True Voice	X	0	
	True Voice	X	0	
Velocity	Note ON	X	0	
	Note OFF	X	0	
After Touch	Key's	X	0	
	Ch's	X	0	
Pitch Bender		X	0	
Control Change		0	0	effects on/off controllers send controller msgs when presets are recalled
Prog Change	True #	X	0-127	assignable to any preset
	True #	X		
System Exclusive		0	0	See: manual
System Common	:Song Pos	X	X	
	:Song Sel	X	X	
	:tune	X	X	
System Real Time	:Clock	X	X	
	:Commands	X	X	
Aux Messages	:Local ON/OFF	X	X	
	:All Notes Off	X	X	
	:Active Sense	X	X	
	:Reset	X	0	

Notes:

1: Factory default is channel 1, OMNI ON. Current setting is maintained in non-volatile RAM and does not change when the

SGX 2000 is powered on.

Mode 1: OMNI ON, POLY	Mode 2: OMNI ON, MONO	O: Yes
Mode 3: OMNI OFF, POLY	Mode 3: OMNI OFF, MONO	X: No

APPENDIX E
MIDI: CONTROLLERS & NUMBERS

CONTROLLER #	CONTROLLER DESCRIPTION
0	UNDEFINED
1	MOD WHEEL
2	BREATH CONTROLLER
3	UNDEFINED
4	FOOT CONTROLLER
5	PORTAMENTO TIME
6	DATA ENTRY (msb)
7	MAIN VOLUME
8	BALANCE
9	UNDEFINED
10	PAN
11	EXPRESSION CONTROLLER
12-15	UNDEFINED
16-19	GENERAL PURPOSE #'S 1-4
20-31	UNDEFINED
32-63	LSB FOR VALUES 0-31
64	DAMPER PEDAL (SUSTAIN)
65	PORTAMENTO
66	SOSTENUTO
67	SOFT PEDAL
68	UNDEFINED
69	HOLD 2
70-79	UNDEFINED (X-15 EFFECTS ON/OFF)
80-83	GENERAL PURPOSE #'S 5-8
84-90	UNDEFINED *84 DEFAULT BYPASS
91	EXTERNAL EFFECTS DEPTH
92	TREMOLO DEPTH
93	CHORUS DEPTH
94	CELESTE (DETUNE) DEPTH
95	PHASER DEPTH
96	DATA INCREMENT
97	DATA DECREMENT
98	NON-REGISTERED PARAMETER # LSB
99	NON-REGISTERED PARAMETER # MSB
100	REGISTERED PARAMETER # LSB
101	REGISTERED PARAMETER # MSB
102-120	UNDEFINED
121-127	RESERVED FOR CHANNEL MODE MESSAGES

CONTINUOUS CONTROLLERS:
 PITCH BEND WHEEL
 CHANNEL PRESSURE
 POLY AFTER TOUCH
 NOTE ON VELOCITY
 NOTE ON KEY #
 NOTE OFF VELOCITY
 NOTE OFF KEY #

DEFAULT MIDI CONTROLLER NUMBERS

X-15 PAD #	EFFECT	MIDI CONTROLLER #
1	EXCITER	70
2	COMPRESSOR	71
3	DISTORTION	72
4	EQUALIZER	73
5	EXPANDER/NOISE GATE	74
6	REVERB	75
7	DELAY	76
8	PITCH TRANSPOSER	77
9	FLANGE/CHORUS	78
10	SPECIAL EFFECTS	79
BYPASS	BYPASS	84

GUITAR OR KEYBOARD INTO SGX 2000, CONTROLLED BY AN X-15 ULTRAFOOT

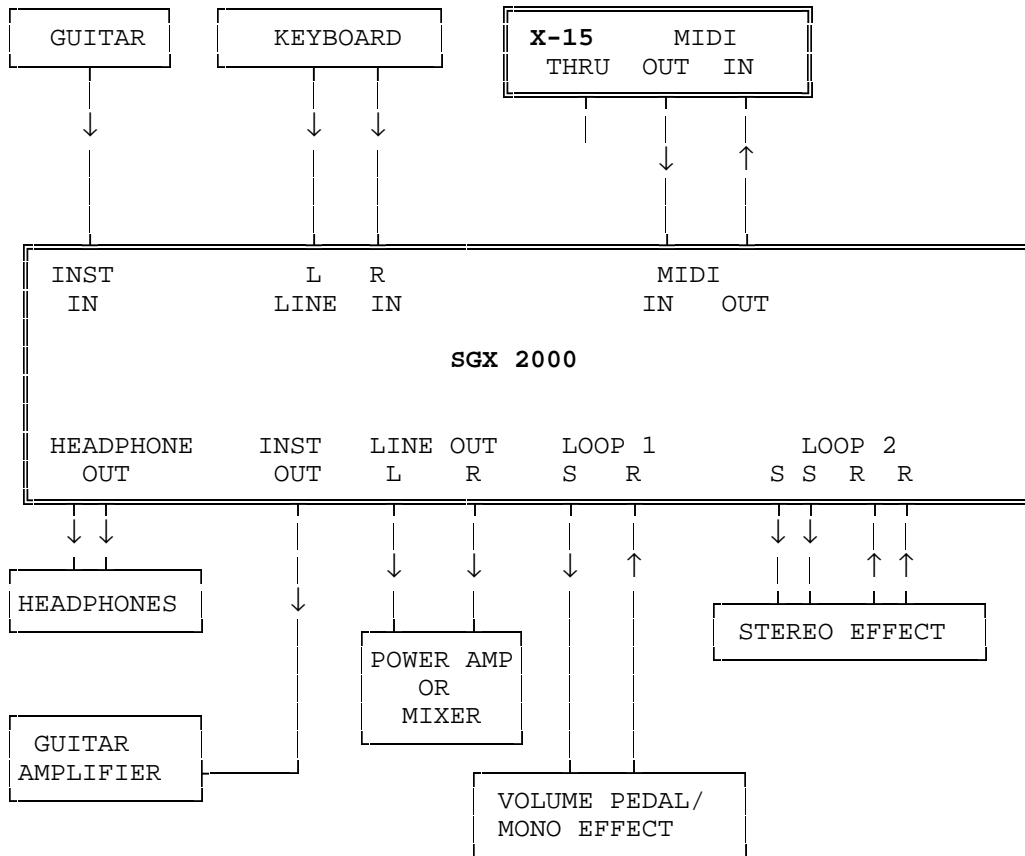

NOTES:

- 1) Not all Inputs and Outputs need be used at once. This diagram shows what may be plugged where.
- 2) If you do use the Instrument and Line Inputs together, the SGX 2000 will mix the inputs and process both together.

APPENDIX G
USING THE SGX 2000 WITH AN X-15 ULTRAFOOT

When an ART X-15 ULTRAFOOT is used with the SGX 2000, remote control of the parameters and the ability to turn on and off the effects themselves greatly extend the capabilities of the SGX 2000. More than half of the SGX 2000's factory presets are set up with MIDI controllers providing you instant access to the parameters with your X-15. Presets 5 and 22 through 30 are designed specifically for use with the X-15 Ultrafoot.

To correctly hook up the two devices, two MIDI cables should be used (see the hookup diagram on the preceding page). Both the SGX 2000 and X-15 "talk" to each other keeping their status' up to date. When the X-15 is in Effect Mode, it will display which effects in the preset are active by lighting the associated pad's LED. If you add, delete, or change the status of an effect with the SGX 2000, the X-15 will monitor and display (or not display if you remove or turn off an effect) the change.

All of the presets in the SGX 2000 with MIDI controllers assigned to them are set to be controlled by MIDI Controllers (MC) 4 and 11. On the X-15, the left expression controller is MC 4 and the right pedal is MC 11. When adding a MIDI controller to a preset in the SGX 2000 the default value for the MIDI controller (screen 2, CONTROLLER IS) is MC 4, Foot Controller. To select another MIDI controller, use the Encoder to change the Value while editing this screen.

Every time a message is sent from the X-15 to the SGX 2000, the SGX's LCD displays the message sent. Effects on and off messages and real time pedal values will be displayed, program change messages (preset changes) will not be displayed. For effects on and off messages to be displayed the X-15 must be in Effect Mode. Anytime either foot controller is moved, the SGX 2000 displays the parameter name and value.

Under the LCD are 16 individual LED's which indicate at all times what effects are present and active in a preset. When an LED is lit, it indicates which effect is present and active in the preset you are currently using. A flashing LED indicates the effect is present in the preset but has been turned "off" from an external controller such as the X-15 ULTRAFOOT.

All of the analog and digital effects parameters (even the MIX) are controllable via the X-15. Some parameters were specifically tuned to be used with foot controllers. These include: compressor output, envelope filter tuning, and any threshold, attack, release or range parameter, distortion output when using TURBO, or JAZZ TUBES, SOLID WARM or TUBE STACK.

WARRANTY & SERVICE INFORMATION

WARRANTY

Warranty service for this unit will be provided by Applied Research & Technology, Inc. in accordance with the following warrant statement.

Applied Research & Technology, Inc. warrants to the original purchaser that this product and the components thereof, will be free from defects in workmanship and materials for a period of one year from the date of purchase. Applied Research & Technology, Inc. (ART) will, without charge, repair or replace, at its option, defective product or component parts upon prepaid delivery to the factory service department or authorized service center, accompanied by proof of purchase date in the form of a valid sales receipt.

EXCLUSIONS: This warranty does not apply in the event of misuse or abuse of the product or as a result of unauthorized alterations or repairs. This warranty is void if the serial number is altered, defaced, or removed.

ART shall not be liable for any consequential damages, including without limitation damages resulting from loss of use. Some states do not allow limitation of incidental or consequential damages, so the above limitation or exclusion may not apply to you. This warranty gives you specific rights and you may also have other rights which vary from state to state.

For units purchased outside The United States, service will be provided by an authorized distributor of Applied Research & Technology, Inc.

SERVICE

The following information is provided for the unlikely event your unit requires service.

- 1) Be sure the unit is the cause of the problem. Check to make sure the unit has power supplied, all cables are connected correctly and the cables themselves are in working condition.
- 2) If you find the unit to be at fault, write down a description of the problem including how and when the problem occurs.
- 3) Call the factory for a Return Authorization (RA) number.
- 4) Pack the unit in it's original carton or a reasonable substitute. The packing box is not recommended for a shipping carton. Put the packaged unit in another box for shipping. Print the RA number clearly under the address.
- 5) Include with your unit: a return shipping address (We cannot ship to a P.O. Box), a copy of your purchase receipt, a daytime phone number, and the description of the problem.
- 6) Ship the unit to:
APPLIED RESEARCH & TECHNOLOGY, INC.
215 TREMONT STREET
ROCHESTER, NY 14608
ATTN: REPAIR DEPARTMENT
RA # _____
- 7) Contact our customer service department at (716) 436-2720 for your Return Authorization number or questions regarding repairs. Customer Service hours are 9:00 AM to 4:00 PM Eastern Time, Monday through Friday.

SGX 2000 PRESET LIST

<p>1 HEAVY METAL SOLO R-DDL-S REV-1 CHO CMP EXP DST NGT EQL AES LVL 1 controller: 4</p>	<p>14 12 STRING HIGH PTR REV-1 CMP EXP HAR EQL AES (no controllers)</p>	<p>27 X-15 JAZZ BEND PTR REV-1 CMP EXP HAR EQL AES LVL 1 controller: 11</p>
<p>2 BRITISH NITRO T-DDL-S CMP EXP DST EQL AES LVL 2 controllers: 11</p>	<p>15 MELLOW 12 STRING PTR REV-1 CMP EXP HAR EQL AES (no controllers)</p>	<p>28 X-15 NOTE BEND PTR REV-1 CMP EXP DST HAR NGT EQL AES LVL 1 controller: 11</p>
<p>3 NUCLEAR TUBES REV-2 PAN CMP EXP DST HAR NGT EQL LVL (no controllers)</p>	<p>16 ROTO LESLIE REV-2 FLA CMP EXP EQL AES LVL 2 controllers: 11</p>	<p>29 X-15 ROCK CHORUS S-DDL-S CHO CMP EXP DST NGT EQL LVL 3 controllers: 4 11</p>
<p>4 MAGGOT MIND WHA S-DDL-S CMP EXP DST ENV NGT EQL LVL 1 controller: 11</p>	<p>17 TAKE ME BACKBABY R-DDL-S REV-1 CHO PAN CMP EXP DST NGT EQL AES LVL (no controller)</p>	<p>30 X-15 FOOT PANNER MPN CMP EXP DST EQL AES LVL 3 controllers: 4 11</p>
<p>5 AUTO GUITAR TUNR TNR CMP NGT 1 controllers: 4</p>	<p>18 ERIC "J" CRUNCH R-DDL-S REV-1 CHO CMP EXP DST NGT EQL AES LVL (no controllers)</p>	<p>31 CLIP AND GRIND S-DDL-S FLA EXP DST NGT EQL AES (no controllers)</p>
<p>6 DARKMAN WHA WHA R-DDL-S REV-1 CHO PAN CMP EXP DST ENV NGT EQL AES LVL (no controllers)</p>	<p>19 FUNK-O-RAMA PTR EXP ENV AES LVL 2 controllers: 11 4</p>	<p>32 GO TO YOUR ROOM LPF REV-1 CHO EXP DST NGT EQL AES LVL (no controllers)</p>
<p>7 ROLLING THUNDER PTR CMP EXP DST NGT EQL AES LVL 1 controller: 11</p>	<p>20 REGGAE STRAT R-DDL-S REV-1 CHO CMP EXP NGT EQL AES LVL (no controllers)</p>	<p>33 VERY PINK LPF R-DDL-S REV-2 FLA EXP DST NGT EQL AES LVL 1 controller: 4</p>
<p>8 HYPERCHORUS REV-1 CHO CMP EXP DST NGT EQL AES LVL (no controllers)</p>	<p>21 MANUAL WHA WHA S-DDL-S CHO CMP EXP DST HAR ENV NGT EQL LVL 1 controller: 11</p>	<p>34 STUDIO TAPS R-DDL-S REV-1 CHO EXP DST NGT EQL AES LVL (no controllers)</p>
<p>9 HYPERFLANGER REV-2 FLA EXP DST HAR NGT EQL LVL (no controllers)</p>	<p>22 X-15 DIVE BOMBER PTR REV-1 CMP EXP DST HAR EQL DGC LVL 2 controllers: 4 11</p>	<p>35 FLANJ IN MY HEAD FLA CMP EXP DST ENV NGT EQL LVL 2 controllers: 11 4</p>
<p>10 MOUNTING CHORUS REV-1 CHO EXP NGT EQL AES DGC LVL 2 controllers: 11 4</p>	<p>23 X-15 HYPERSWEEP PTR REV-1 CMP EXP DST HAR NGT EQL DGC LVL 2 controllers: 4 11</p>	<p>36 JAZZ CHORUS S-DDL-S CHO CMP DST LVL 2 controllers: 11 4</p>
<p>11 ARCTIC AMBIENCE R-DDL-L REV-1 FLA EXP ENV NGT EQL AES DGC LVL 3 controllers: 11 4</p>	<p>24 CONCERT X-15 WHA S-DDL-L CMP EXP DST HAR ENV NGT EQL LVL 1 controller: 11</p>	<p>37 CNTRY&BLUES SUS. T-DDL-S REV-2 CMP EXP DST HAR NGT EQL DGC LVL (no controllers)</p>
<p>12 ACOUSTICHORUS REV-1 CHO CMP EXP HAR EQL AES DGC LVL 3 controllers: 11 4</p>	<p>25 X-15 CHORUS PAN S-DDL-S CHO MPN HAR AES LVL 1 controller: 11</p>	<p>38 MELLOW JAZZ LPF REV-1 CHO TRM CMP DST NGT EQL AES 3 controllers: 4 11</p>
<p>13 DIRE STRAIT PTR REV-1 EXP EQL AES LVL 2 controllers: 4</p>	<p>26 X-15 VARI CHORUS S-DDL-S CHO HAR EQL AES LVL 3 controllers: 4 11</p>	<p>39 JAZZY DELAYS LPF S-DDL-L TRM CMP DST HAR NGT EQL AES (no controllers)</p>

40	JAZZ NITE CLUB TRM CMP EXP DST EQL 1 controller: 11	GAT-2 CMP EXP DST HAR NGT EQL AES LVL 1 controller: 11	(no controllers)
41	SKYWATCH S-DDL-S FLA EXP HAR EQL 2 controllers: 11 4	57 JIMI'S WHA R-DDL-S CHO PAN CMP EXP DST ENV NGT AES LVL 2 controllers: 4 11	73 SUPER NOVA T-DDL-L REV-1 CMP EXP DST NGT EQL LVL 1 controller: 11
42	MR. CLEAN REV-1 CHO CMP EXP HAR EQL AES LVL 2 controllers: 11 4	58 SMOOTH PAUL SOLO R-DDL-S REV-1 CMP EXP DST NGT EQL AES LVL 2 controllers: 11 4	74 2112 R-DDL-S REV-3 DST HAR NGT EQL AES LVL 2 controllers: 11 4
43	BLISSFULL CHORUS REV-1 CHO CMP EXP NGT EQL AES 2 controllers: 4 11	59 CHORUS SLAPBACK LPF CHO GAT-1 CMP EXP DST NGT EQL AES DGC 1 controller: 11	75 METALWORKS S-DDL-S FLA DST HAR NGT EQL AES LVL 4 controllers: 11 4
44	FAT FLANGER LPF R-DDL-S REV-1 FLA PAN CMP EXP HAR EQL AES LVL 3 controllers: 11 4	60 ROCK BLUEZ R-DDL-S REV-2 PAN CMP EXP DST NGT EQL AES LVL (no controllers)	76 NIGHTCRY T-DDL-L REV-1 CMP DST HAR ENV NGT EQL AES LVL 4 controllers: 11 4
45	THE RIVER LPF R-DDL-S REV-2 FLA EXP HAR EQL AES 2 controllers: 11 4	61 THY BLUES R-DDL-S REV-2 FLA CMP EXP DST HAR NGT EQL DGC LVL 2 controllers: 11	77 ROADKILL S-DDL-S CHO CMP EXP DST EQL LVL 3 controllers: 11 4
46	ENGLISH STACK (no digital) EXP DST NGT EQL AES LVL (no controllers)	62 NITRO! R-DDL-S CHO PAN EXP DST HAR NGT EQL AES LVL 2 controllers: 11 4	78 MUDBONE R-DDL-S REV-1 CHO CMP DST NGT EQL AES LVL 2 controllers: 11 4
47	SUPER TUBE O.D. (no digital) CMP EXP DST NGT EQL AES LVL (no controllers)	63 PITBULL R-DDL-S REV-1 CHO EXP DST NGT EQL LVL 2 controllers: 11 4	79 ICEBREAKER S-DDL-L FLA DST HAR NGT EQL LVL 2 controllers: 11 4
48	SGX TUBE STACK (no digital) CMP EXP DST EQL AES LVL (no controllers)	64 LED FOOT PTR- REV-1 EXP DST HAR EQL AES LVL (no controllers)	80 WAH SWELL REV-1 CHO CMP EXP DST ENV NGT LVL (no controllers)
49	RAW HEAT (no digital) EXP DST NGT EQL AES LVL (no controllers)	65 VANILLA CRUNCH REV-1 CMP DST HAR NGT EQL LVL 2 controllers: 11 4	81 NIGHT WARBLER REV-2 FLA CMP EXP EQL AES LVL 1 controller: 11
50	HAMMERTONE LPF PTR REV-1 EXP DST NGT EQL AES (no controllers)	66 POWER CHORD DBL1 LPF S-DDL-S CHO EXP DST NGT EQL AES LVL 2 controllers: 11 4	82 SPACE CLIMBER R-DDL-S PTR REV-1 HAR AES 2 controllers: 11 4
51	S WALL T-DDL-S REV-2 EXP DST NGT EQL DGC 4 controllers: 4 11	67 POWER CHORD DBL2 LPF S-DDL-S FLA EXP DST NGT EQL AES LVL 2 controllers: 11 4	83 FOREVER FLANGE S-DDL-S FLA CMP EXP DST NGT LVL 2 controllers: 11 4
52	BIG CHORDS→CHOR S-DDL-S CHO EXP DST HAR NGT EQL 1 controller: 11	68 POWER PUMP 1 LPF R-DDL-S REV-1 CHO EXP DST NGT EQL AES (no controllers)	84 PURPLE PLUS LPF PTR REV-1 CMP EXP DST EQL AES LVL 1 controller: 4
53	CUT THRASH REV-2 CMP EXP DST HAR NGT EQL LVL (no controllers)	69 POWER PUMP 2 LPF R-DDL-S REV-1 CHO EXP DST NGT EQL AES LVL (no controllers)	85 YES YES YES LPF PTR REV-1 EXP DST NGT EQL AES LVL 1 controller: 4
54	S CONCERT R-DDL-L REV-1 TRM CMP EXP DST EQL AES LVL 1 controller: 11	70 STACK IN A BOX LPF REV-3 CMP EXP DST NGT EQL AES LVL (no controllers)	86 KICKIN' STRAT T-DDL-S REV-1 CMP EXP NGT EQL AES 1 controller: 11
55	SANDMAN METAL CHO GAT-1 CMP EXP DST NGT EQL AES LVL 2 controllers: 11	71 HIT & HOLD S-DDL-S CHO TRM DST ENV EQL DGC LVL 2 controllers: 4 11	87 U-TOO STRAT R-DDL-L PTR CMP EXP NGT EQL AES 1 controller: 11
56	GARAGE BAND	72 JET STREAM LPF R-DDL-L PTR CMP EXP DST ENV NGT EQL AES LVL	88 JAZZ CAT T-DDL-S REV-2 CMP HAR EQL AES DGC LVL 2 controllers: 4

89	BIRDMAN S-DDL-S FLA HAR EQL 2 controllers: 11 4	94	PICK ON ME R-DDL-S REV-1 FLA CMP HAR EQL LVL 2 controllers: 11 4	106	WALSH WASH R-DDL-S REV-1 FLA EQL AES 2 controllers: 11 4
90	WAVY DRAPES R-DDL-S REV-2 FLA PBY CMP HAR NGT EQL AES LVL 2 controllers: 11 4	95	ERIC J CLEAN R-DDL-S REV-1 CHO CMP EXP EQL (no controllers)	107	FUZZ ORGAN PTR REV-1 CMP EXP DST HAR EQL AES LVL (no controllers)
91	GUITAR ANGEL R-DDL-L REV-1 TRM DST HAR NGT EQL AES LVL 2 controllers: 11 4	96	HEARTBREAKER PTR REV-1 CMP AES DGC 2 controllers: 11 4	108	TURBO LESLIE REV-2 FLA CMP EXP DST NGT EQL AES LVL 2 controllers: 11
92	NAKED CHO S-DDL-S CHO DST HAR LVL 2 controllers: 11 4	97	FUNKIT! REV-1 CHO CMP EXP HAR EQL AES LVL 2 controllers: 11 4	109	THICK CHO R-DDL-S REV-1 FLA PAN EXP DST NGT EQL AES 2 controllers: 11 4
93	SHIMMER STRAT S-DDL-S CHO CMP EXP DST HAR EQL LVL 2 controllers: 11 4	98	SAMPLE & HOLD SMP-S REV-2 DST NGT LVL 2 controllers: 11 4	110	BORUS CHORUS LPF R-DDL-S REV-1 CHO PAN CMP EXP HAR EQL AES (no controllers)
		99	DEE-DA DEE-DA S-DDL-S CHO HAR AES LVL 2 controllers: 11 4	111	HIGH WATZ LPF T-DDL-S REV-2 CMP EXP DST EQL AES LVL 2 controllers: 11
		100	(no digital) (no analog) (no controllers)	112	"51" TWEED VBLUX R-DDL-S REV-2 CMP EXP DST HAR NGT EQL AES LVL 2 controllers: 4 11
		101	GUITAR SOUP R-DDL-S REV-1 FLA CMP DST HAR NGT EQL LVL 2 controllers: 11 4	113	GUITAR TUNER X15 TNR CMP NGT 1 controller: 4
		102	OCTAVIA PTR REV-1 DST NGT EQL AES LVL 3 controllers: 11 4	114	LOOK MA NO HANDS PTR REV-1 DST 1 controller: 11
		103	DARKMAN FLA CMP EXP DST NGT EQL AES LVL 2 controllers: 11 4	115	SLASHED LPF GAT-3 CMP DST NGT EQL (no controllers)
		104	PIRANHA R-DDL-S CHO CMP DST NGT AES LVL 2 controllers: 11 4		
		105	DEPTH CHARGE REV-3 DST HAR EQL AES LVL 2 controllers: 11 4		

How to Read the Preset Description

42	MR. CLEAN	→ Title Line
	REV-1 CHO	→ Digital Effects Line
	CMP HAR EQL AES LVL	→ Analog Effects Line
	2 controllers: 11 4	→ MIDI Controller Line

The first line of the preset description tells you the name and location of each Factory Preset on the first line. On the next line, which digital effects present in the preset are shown. Analog effects used for the preset are listed on the third line. How many and which MIDI controllers are listed on the last line.

Table of Effect Abbreviations:

First is the abbreviation found in the preset list. Next is the actual effect algorithm name. In brackets, how the algorithm name is displayed in the LCD. For a description of the algorithms and parameters, refer to the section "Description of Algorithms".

AES = ACOUSTIC ENVIRONMENT SIMULATOR [ACU-ENV-SIM], [AES]
 CHO = CHORUS [CHORUS], [CHO]
 CMP = COMPRESSOR [COMPRESSOR], [CMP]
 DGC = DIGITAL CONTOUR [DIG CONTOUR], [DGC]
 DST = DISTORTION [DISTORTION], [DST]
 ENV = ENVELOPE FILTER [ENVLP FILTER], [ENV]
 EQL = EQUALIZER (SEVEN BAND EQUALIZER) [EQUALIZER],[EQL]
 EXP = EXPANDER [EXPANDER], [EXP]
 FLA = FLANGER [FLANGER], [FLA]
 GAT-1 = GATED REVERB-1 [GATE-VERB-1], [GAT]
 GAT-2 = GATED REVERB-2 [GATE-VERB-2], [GAT]
 GAT-3 = GATED REVERB-3 [GATE-VERB-3], [GAT]
 HAR = HARMONIC EXCITER [HAR-EXCITER], [EXC]
 LPF = LOW PASS FILTER [LOW-PASS], [LPF]
 LVL = PROGRAMMABLE LEVEL [PROGR LEVEL], [LVL]
 MPN = MIDI-PAN [MPN]
 NGT = NOISE GATE [NOISE GATE], [NGT]
 PAN = PANNER [PANNER], [PAN]
 PBX = PATCH BAY [PATCH BAY], [PBX]
 PTR = PITCH TRANSPOSER [PITCH-TRANS], [PTR]
 R-DDL-S = REGEN-DDL-SHORT [REGEN-DDL-S], [DDL]
 R-DDL-L = REGEN-DDL-LONG [REGEN-DDL-L], [DDL]
 REV-1 = REVERB-1 [REVERB-1], [REV]
 REV-2 = REVERB-2 [REVERB-2], [REV]
 REV-3 = REVERB-3 [REVERB-3], [REV]
 S-DDL-S = STEREO-DDL-SHORT [STEREO-DDL-S], [DDL]
 S-DDL-L = STEREO-DDL-LONG [STEREO-DDL-L], [DDL]
 SMP-S = SAMPLER-SHORT [SAMPLER-S], [SMP]
 SMP-L = SAMPLER-LONG [SAMPLER-L], SMP
 SMP+PTR = SAMPLER+PITCH TRANSPOSER [SAMPLER+PTR], [SPT]
 T-DDL-S = TAPPED-DDL-SHORT [TAP'D-DDL-S], [DDL]
 T-DDL-L = TAPPED-DDL-LONG [TAP'D-DDL-L], [DDL]
 TNR = GUITAR TUNER [TUNER], [TNR]
 TRM = TREMOLO [TREMOLO], [TRM]